

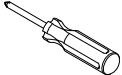

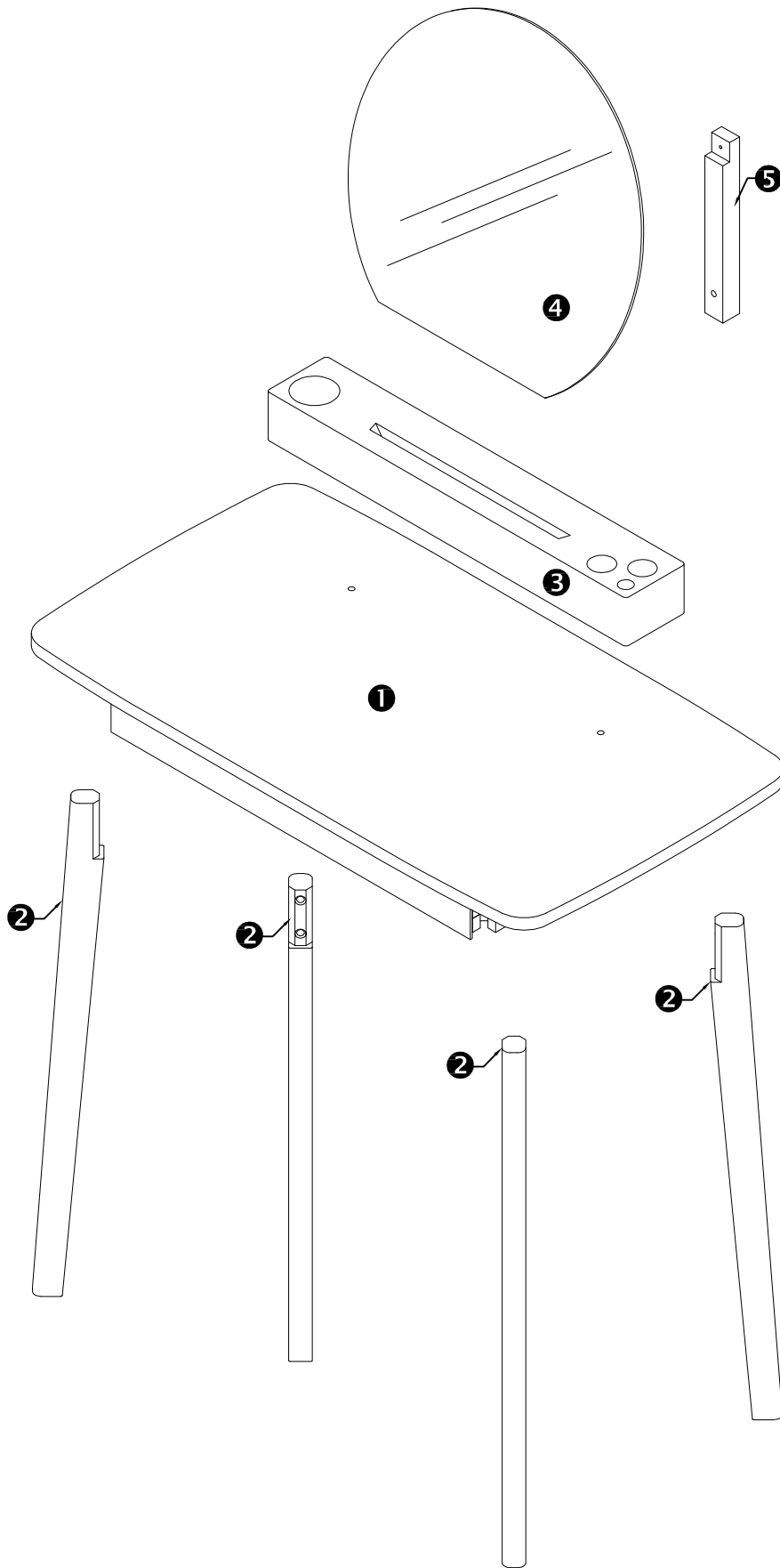

 30 MIN		
--	---	---



<p>A M4*30*115</p>  <p>x 1</p>	<p>B Ø6*Ø19 mm</p>  <p>x 8</p>	<p>C M6*60 mm</p>  <p>x 8</p>	<p>D M6*35 mm</p>  <p>x 3</p>	<p>E 3.5*25mm</p>  <p>x 1</p>
--	--	---	---	---

