

ANTALYA

116 665



a = 201 cm

b = 73 cm

c = 86 cm

d = 34 cm

e = 125 cm

f = 75 cm

g = 29,5 cm

h = 4,5 cm

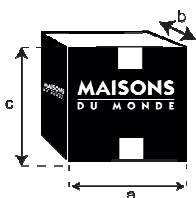
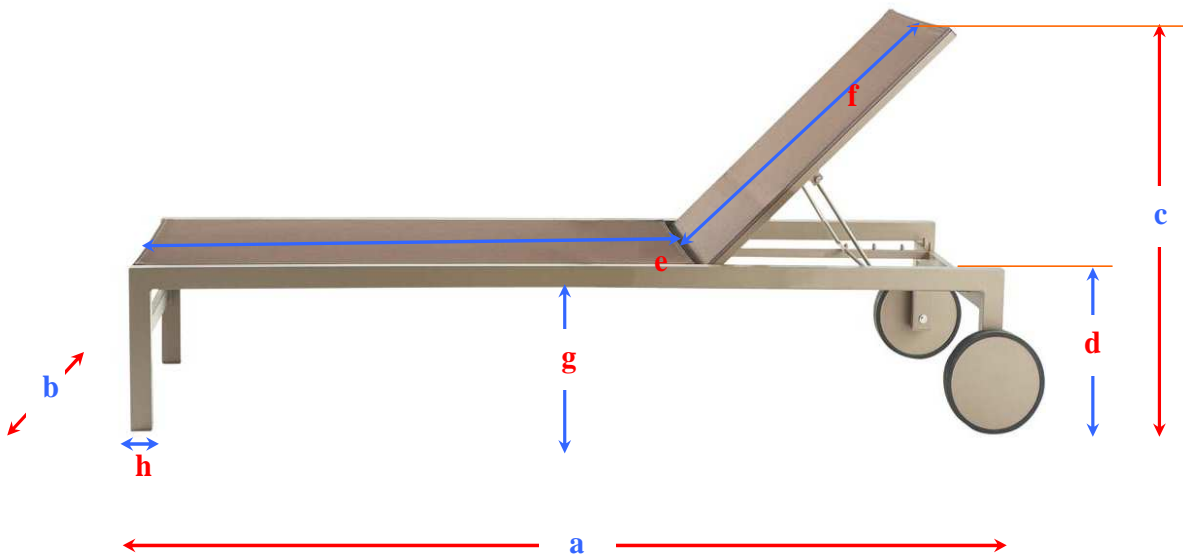

X 1

a = 76 cm

b = 36 cm

c = 210 cm

= 15 Kg