

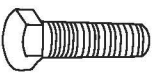





<p><b>A</b></p>  <p>Ø8X30 MM X8+2</p>	<p><b>B</b></p>  <p>X1</p>	<p><b>C</b></p>  <p>M8 X8+2</p>	<p><b>D</b></p>  <p>X4+2</p>
--	---	--	---

1

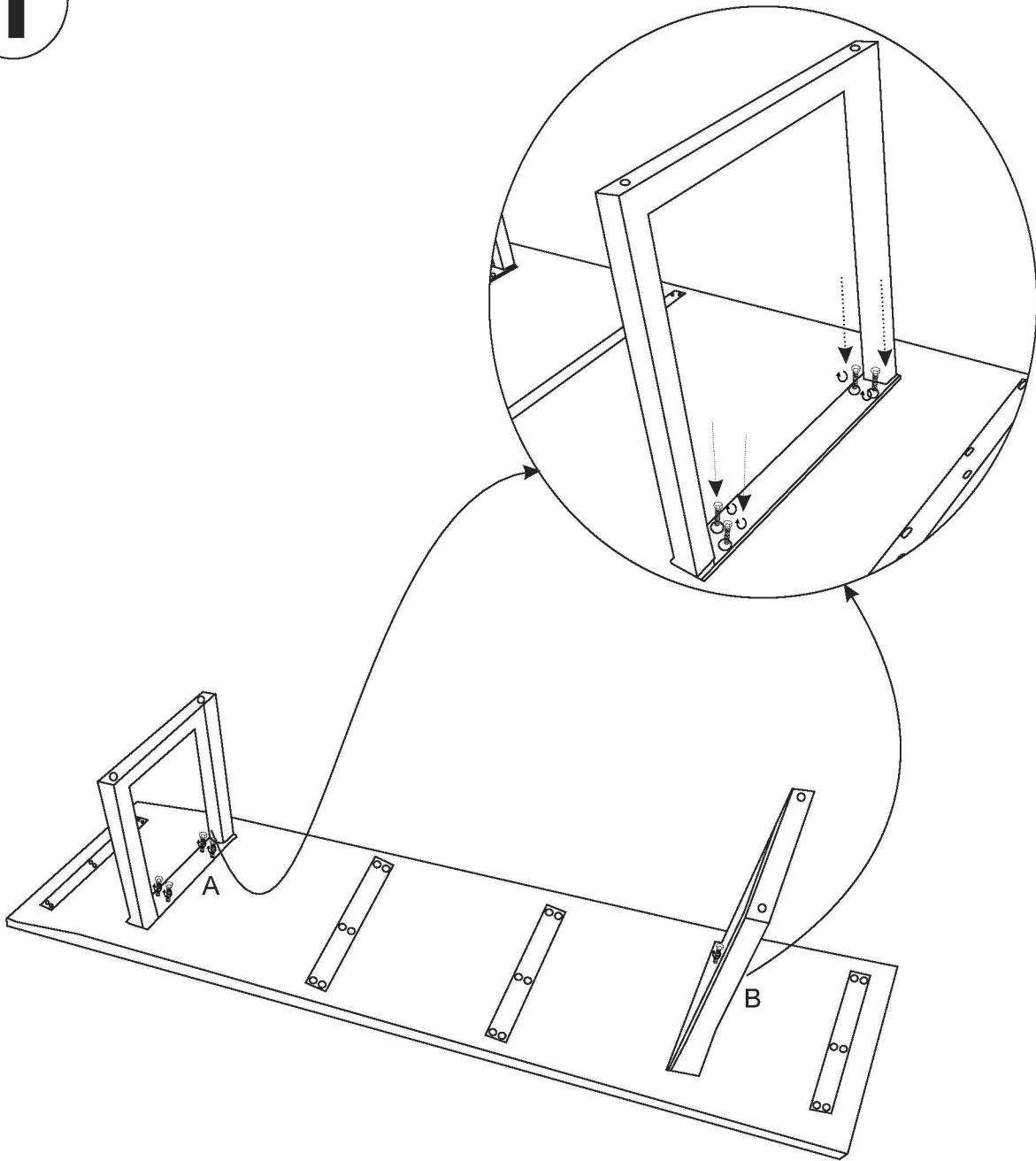
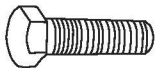

<p><b>A</b></p>  <p>Ø8X30 MM X8+2</p>	<p><b>B</b></p>  <p>X1</p>	<p><b>C</b></p>  <p>M8 X8+2</p>
--	---	--