

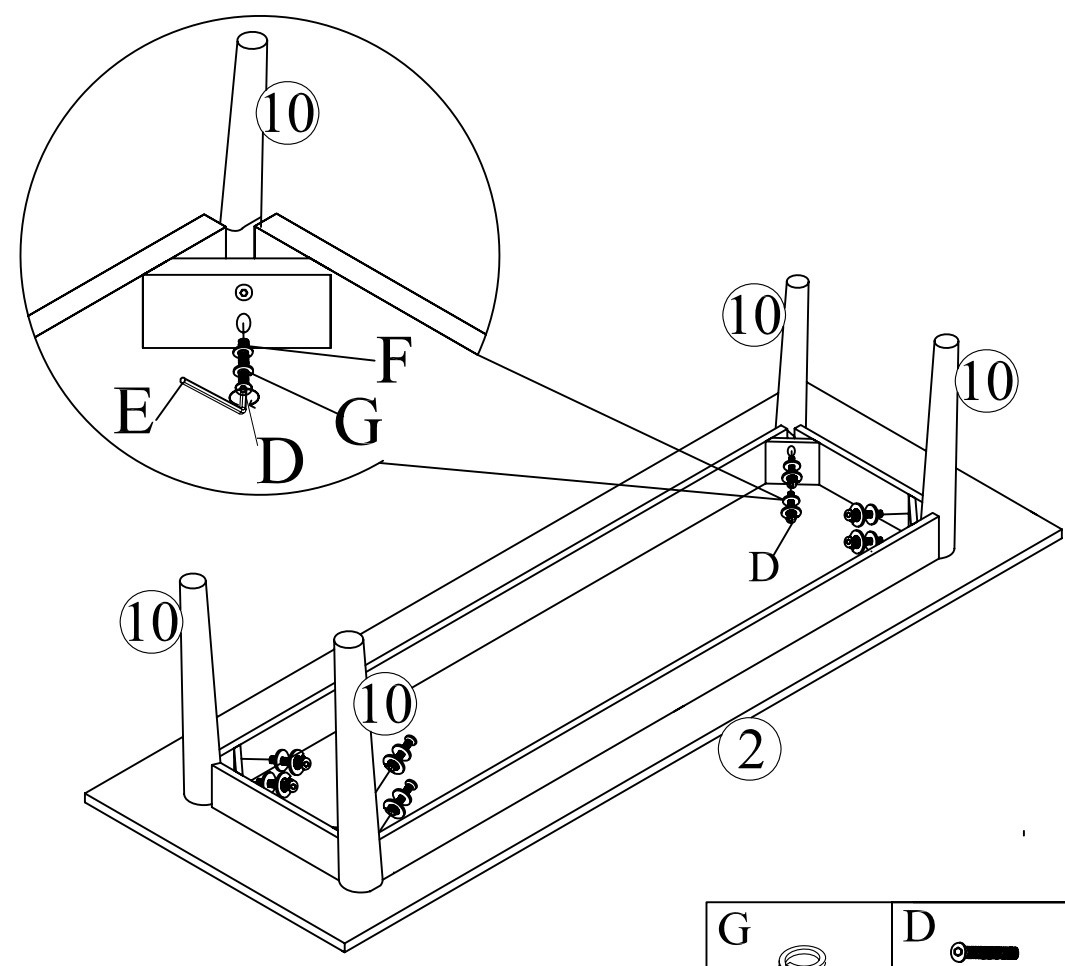







1



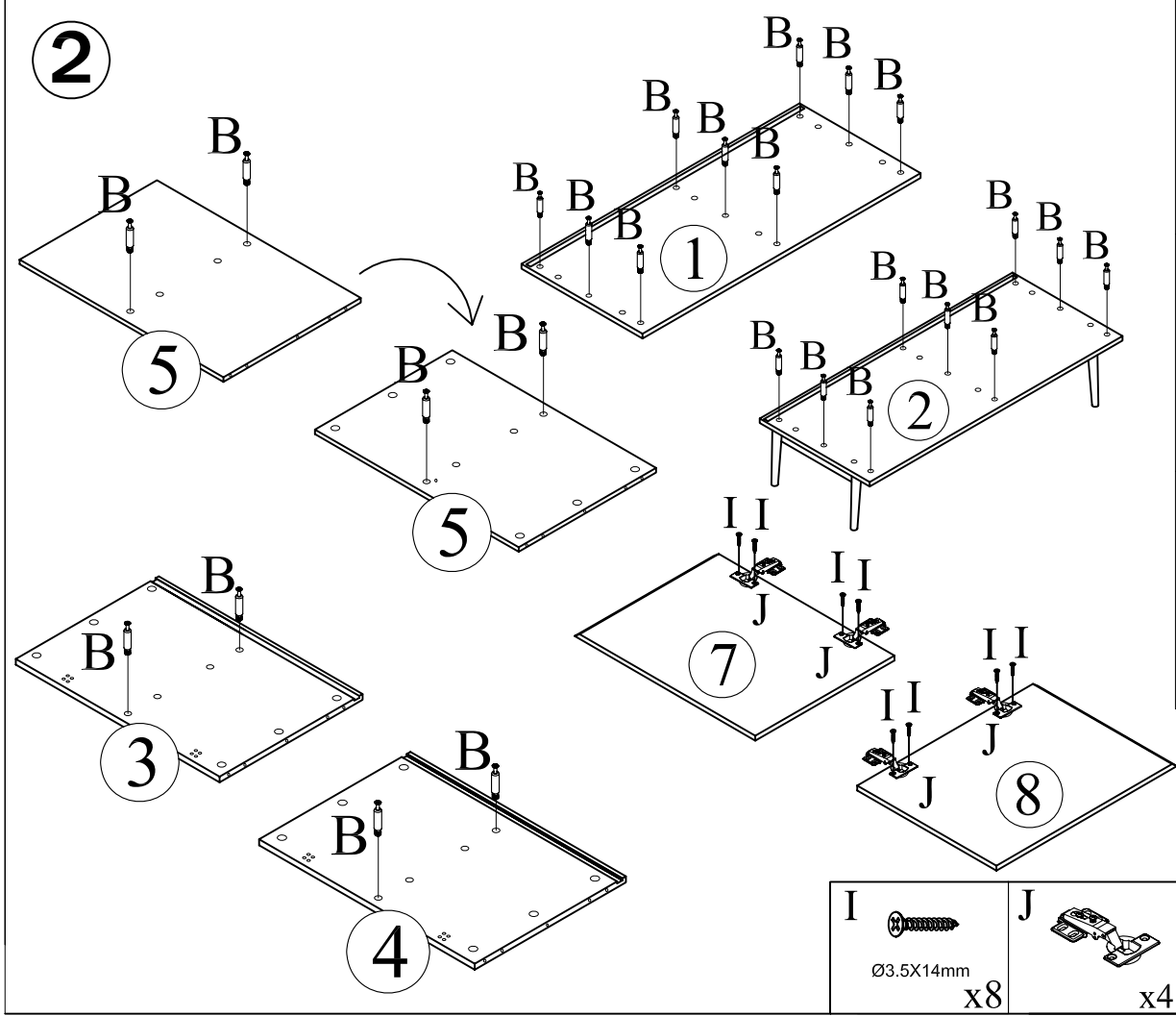

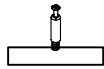
<p>G</p>  <p>Ø6mm x8</p>	<p>D</p>  <p>Ø6X60mm x8</p>	<p>F</p>  <p>Ø6mm x8</p>
		<p>E</p>  <p>x1</p>

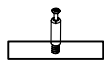
2

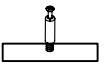
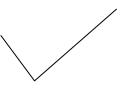

<p>1</p>  
<p>2</p>  
<p>3</p>  

<p>I</p>  <p>Ø3.5X14mm x8</p>	<p>J</p>  <p>x4</p>	<p>B</p>  <p>Ø6.5 x35mm x26</p>
--	--	--

3

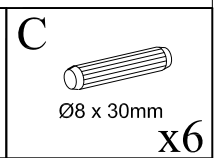
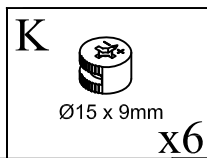
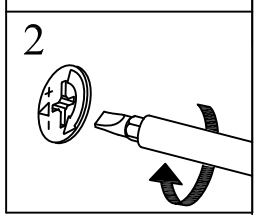
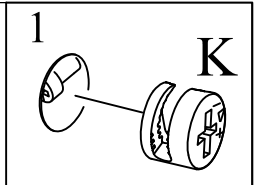
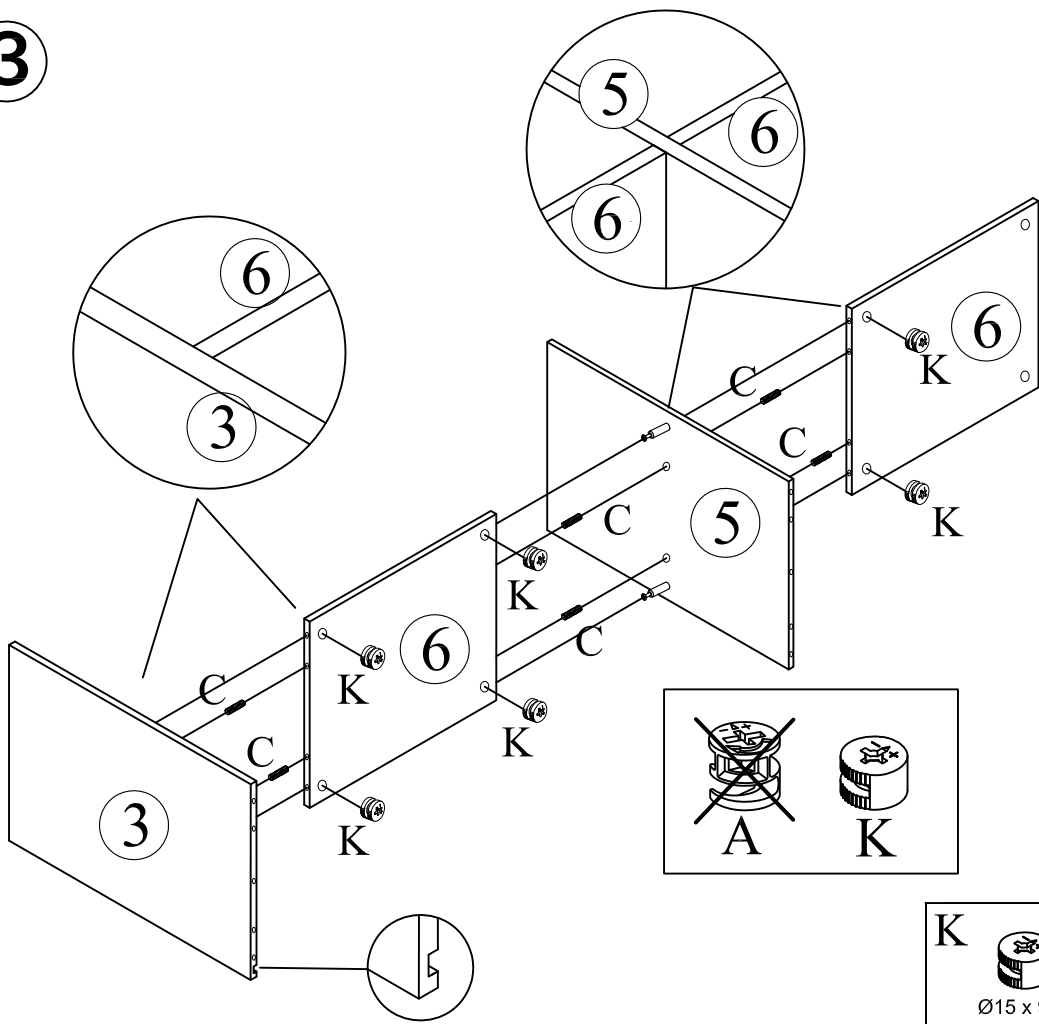

4

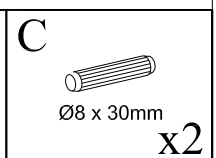
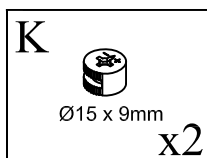
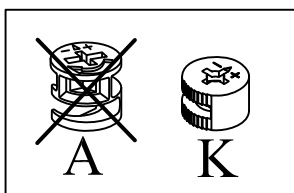
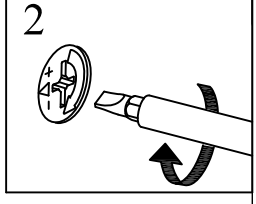
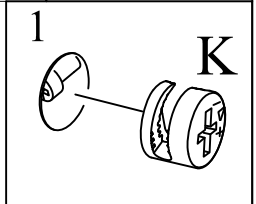
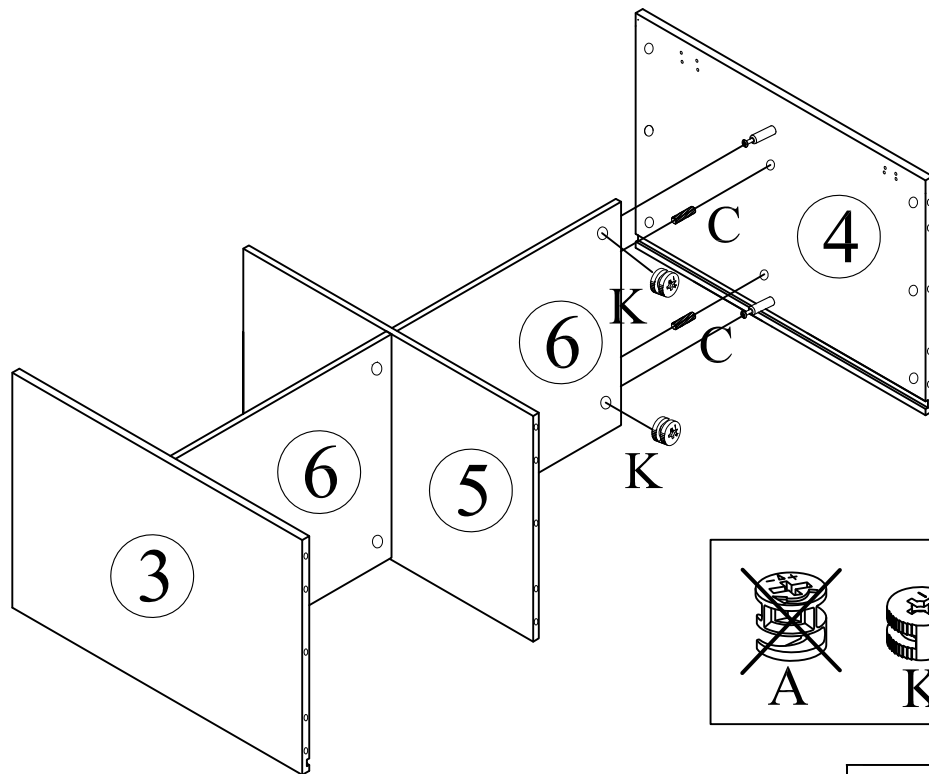

5

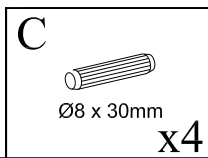
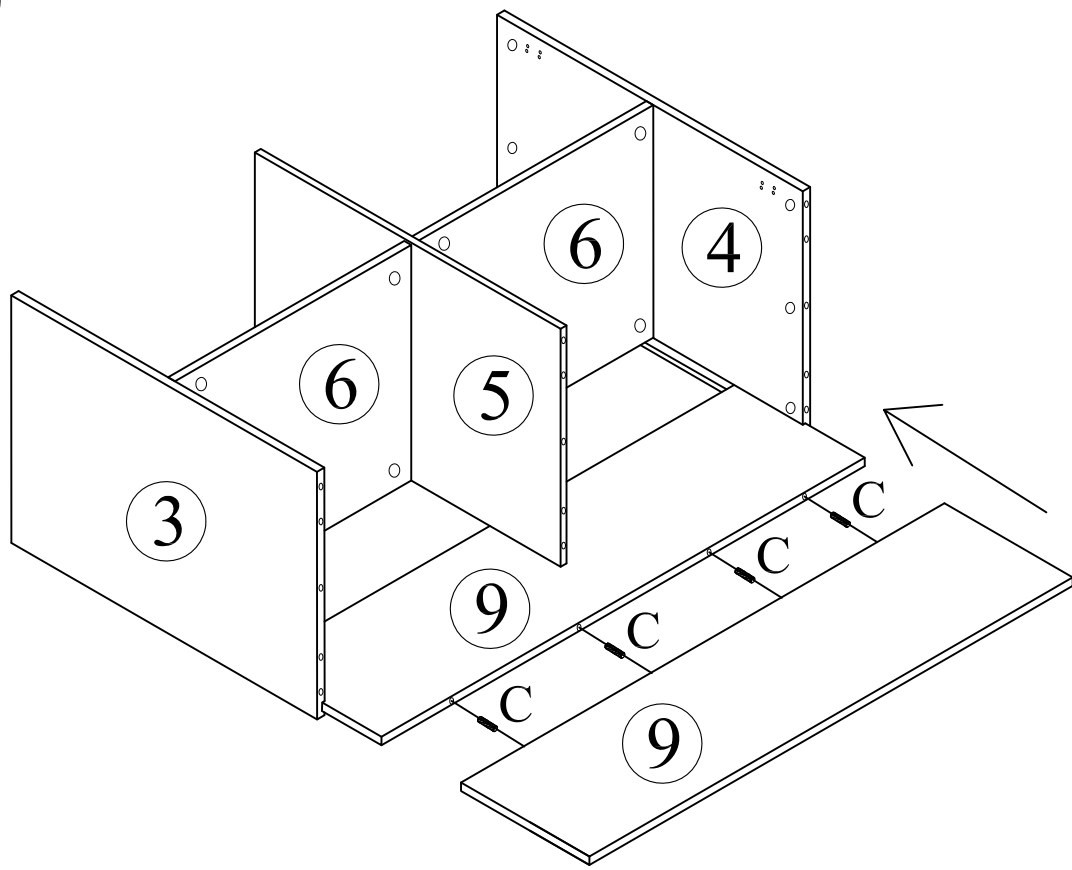

6

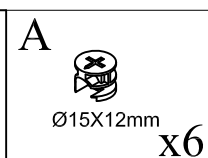
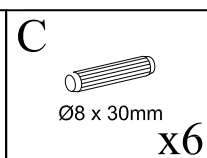
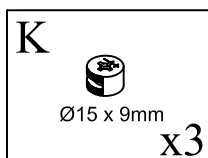
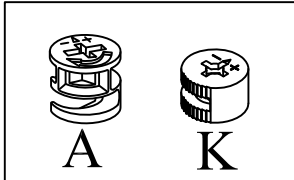
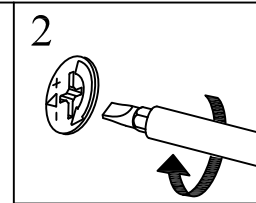
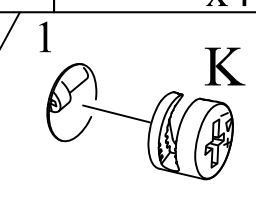
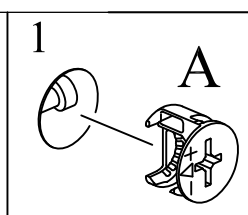
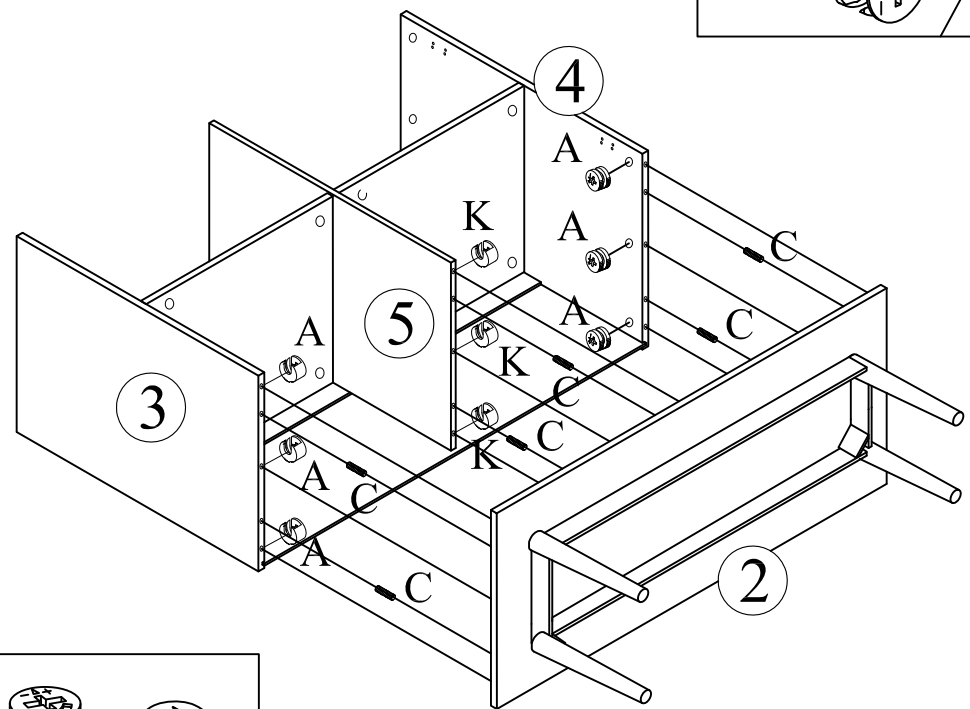

7

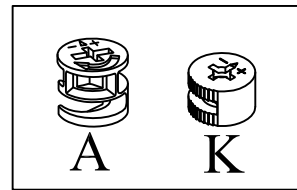
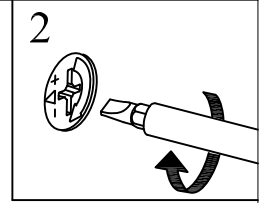
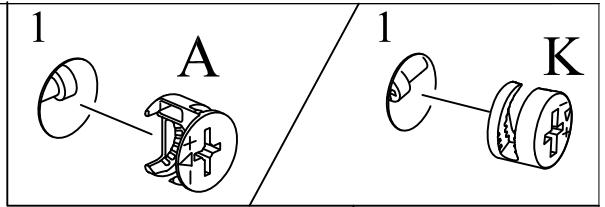
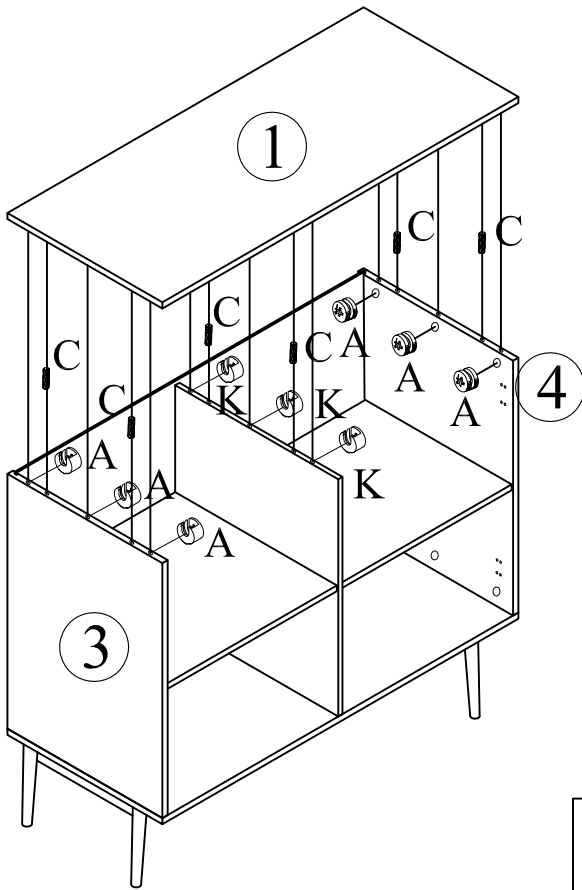

<p>K</p> <p>Ø15 x 9mm x3</p>	<p>C</p> <p>Ø8 x 30mm x6</p>	<p>A</p> <p>Ø15X12mm x6</p>
----------------------------------	----------------------------------	---------------------------------

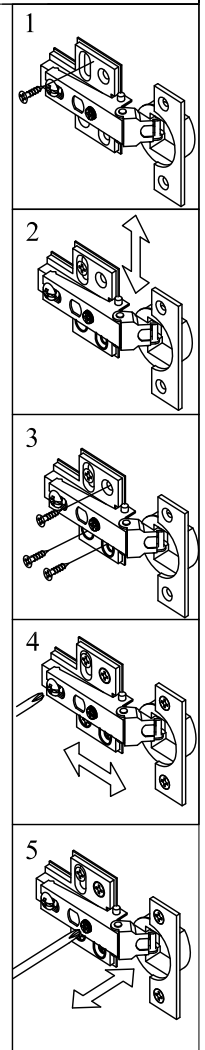
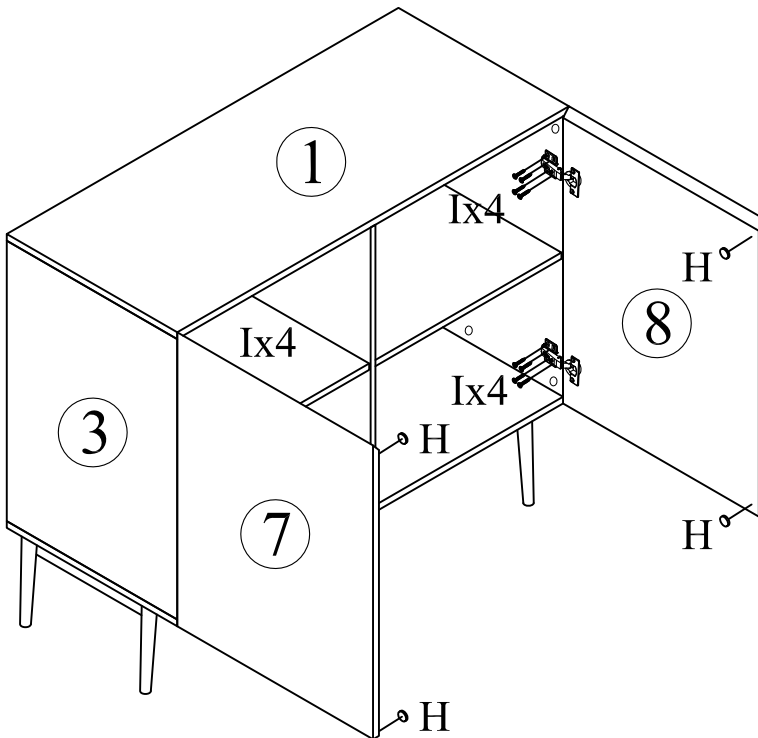

8

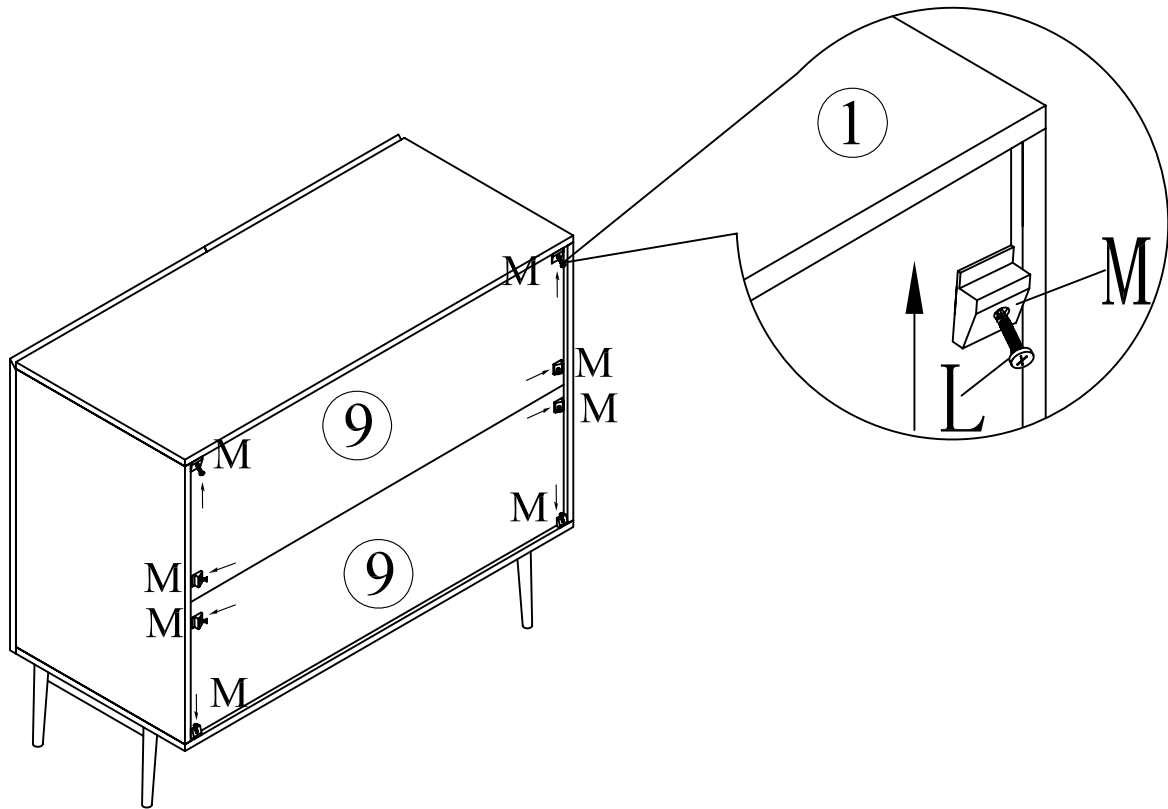

<p>I</p> <p>Ø3.5X14mm x16</p>	<p>H</p> <p>x4</p>
-----------------------------------	--------------------

9



<p>L  Ø3X20mm x8</p>	<p>M  x8</p>
--	--

