

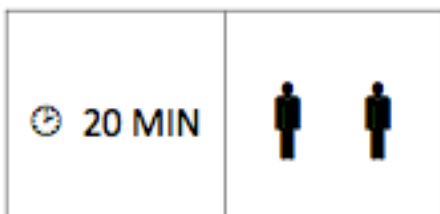

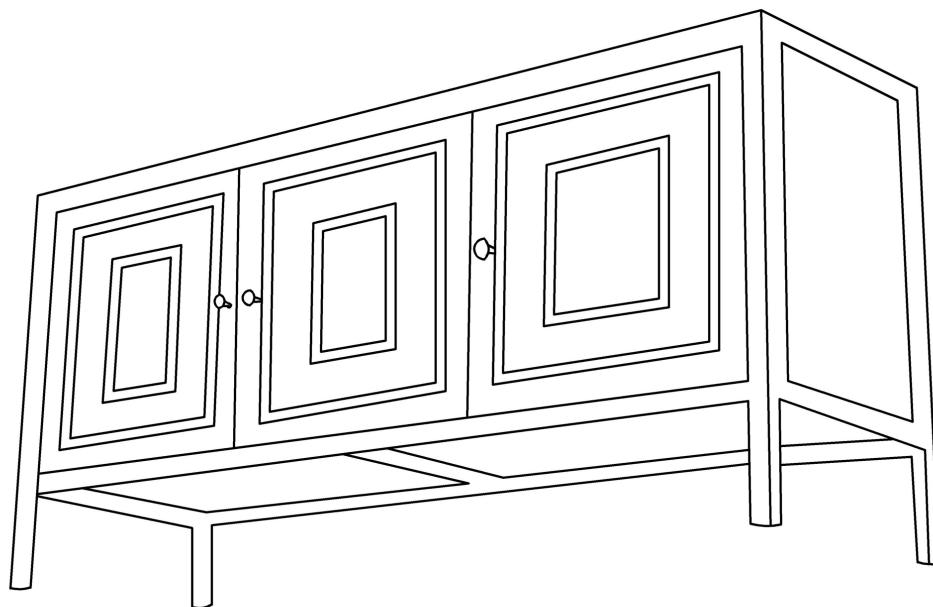

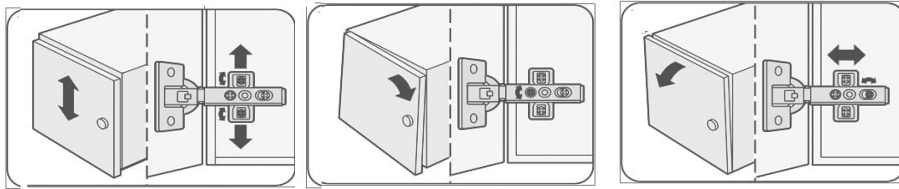

# TOPAZE

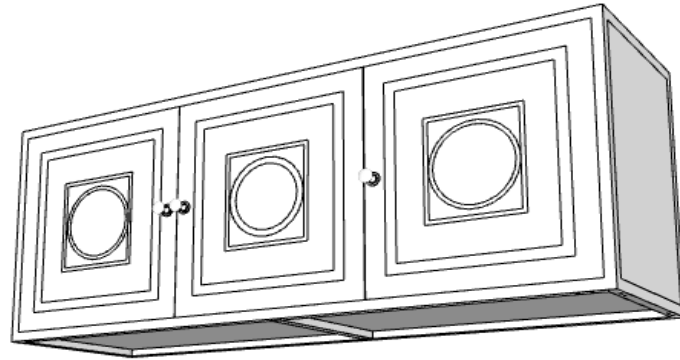



198423



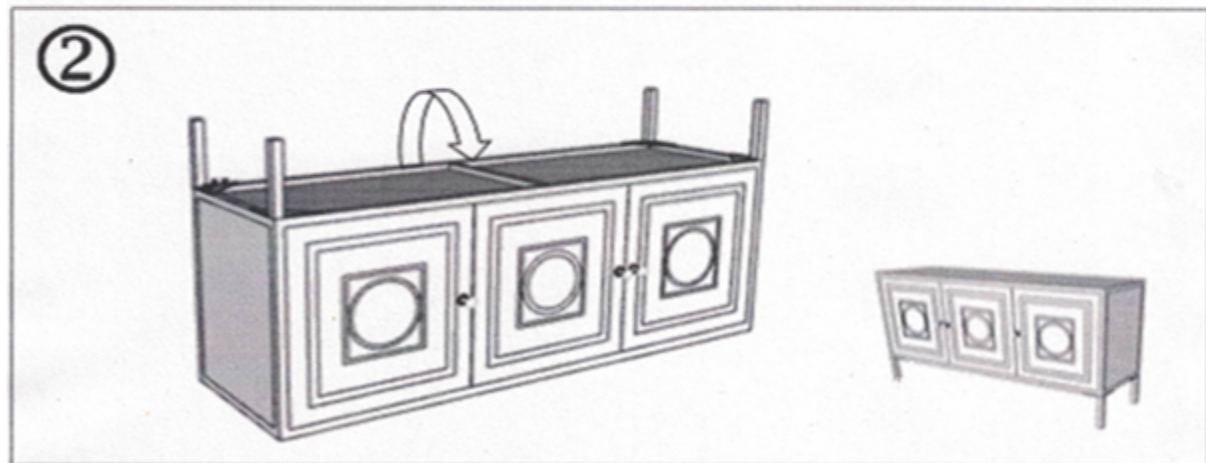
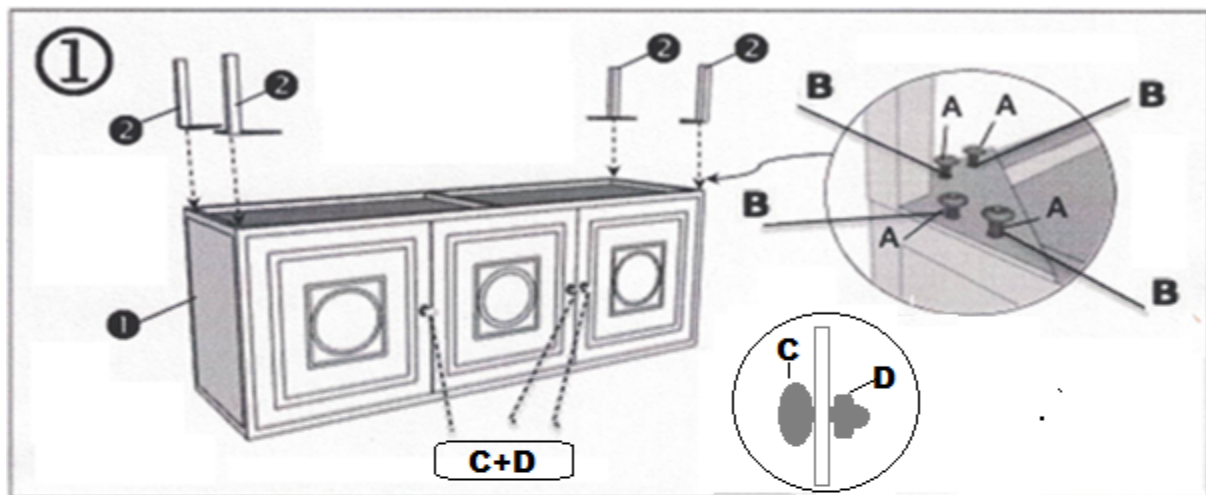

<p><b>A</b></p>  <p>Ø 12X 20mm X16+2</p>	<p><b>B</b></p>  <p>M12 X16+2</p>	<p><b>C</b></p>  <p>Ø 8X 32mm X3</p>	<p><b>D</b></p>  <p>M8 X3</p>	<p><b>E</b></p>  <p>X1</p>
---	--	---	---	---



<p><b>A</b></p>  <p>Ø 12X 20mm X16+2</p>	<p><b>B</b></p>  <p>M12 X16+2</p>	<p><b>C</b></p>  <p>Ø 8X 32mm X3</p>	<p><b>D</b></p>  <p>M8 X3</p>	<p><b>E</b></p>  <p>X1</p>
---	--	---	--	---