











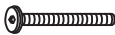

A 6 * 15mm  X16	B 4 mm  X1	C 6 * 70mm  X2	D 6*13 mm  X2	E 8*30 mm  X2	F 6 * 25mm  X4
---	--	--	---	---	--

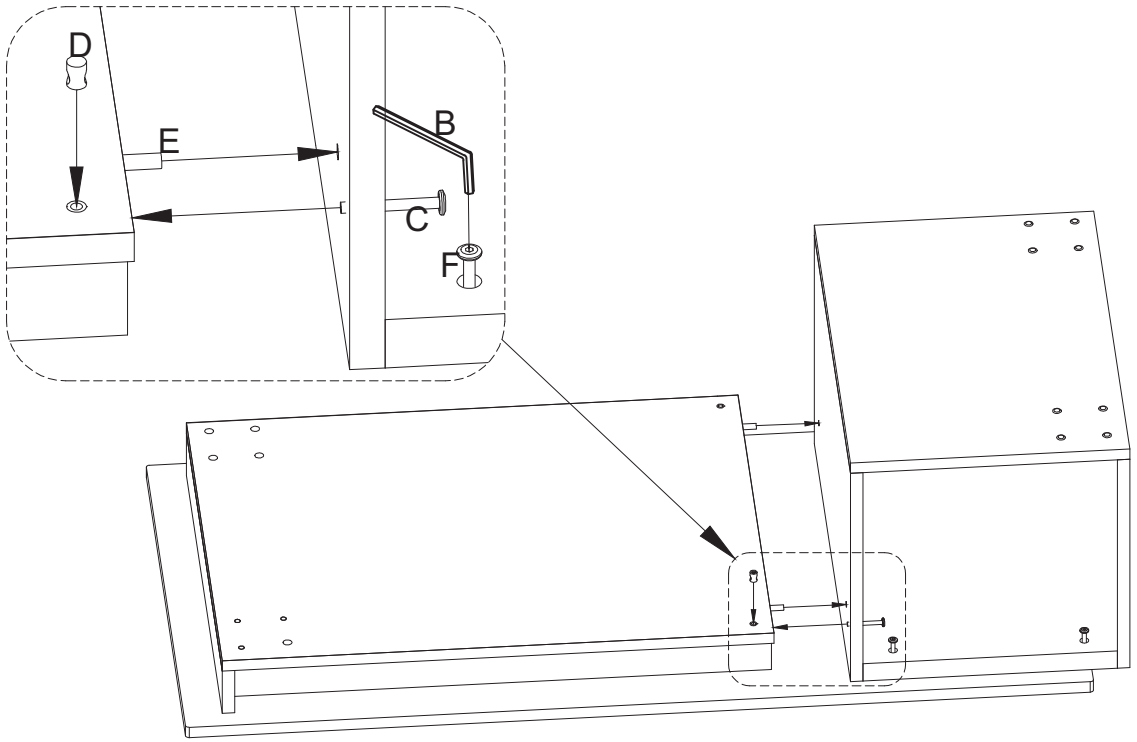



1

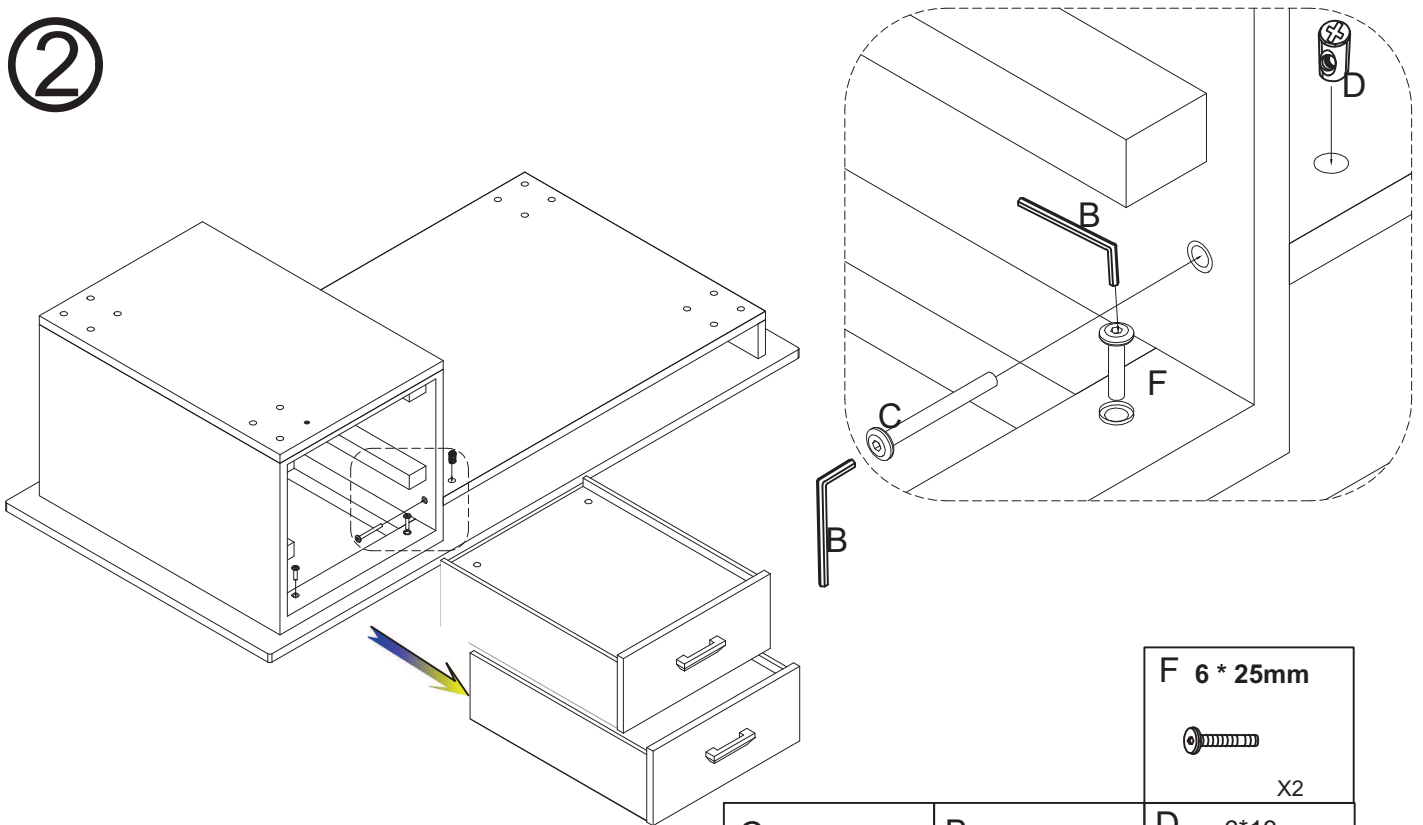

B 4 mm  X1	C 6 * 70mm  X1	E 8*30 mm  X2	D 6*13 mm  X1	F 6 * 25mm  X2
---	---	--	--	---

2



C 6 * 70mm  X1	B 4 mm  X1	F 6 * 25mm  X2	D 6*13 mm  X1
--	--	--	---

③

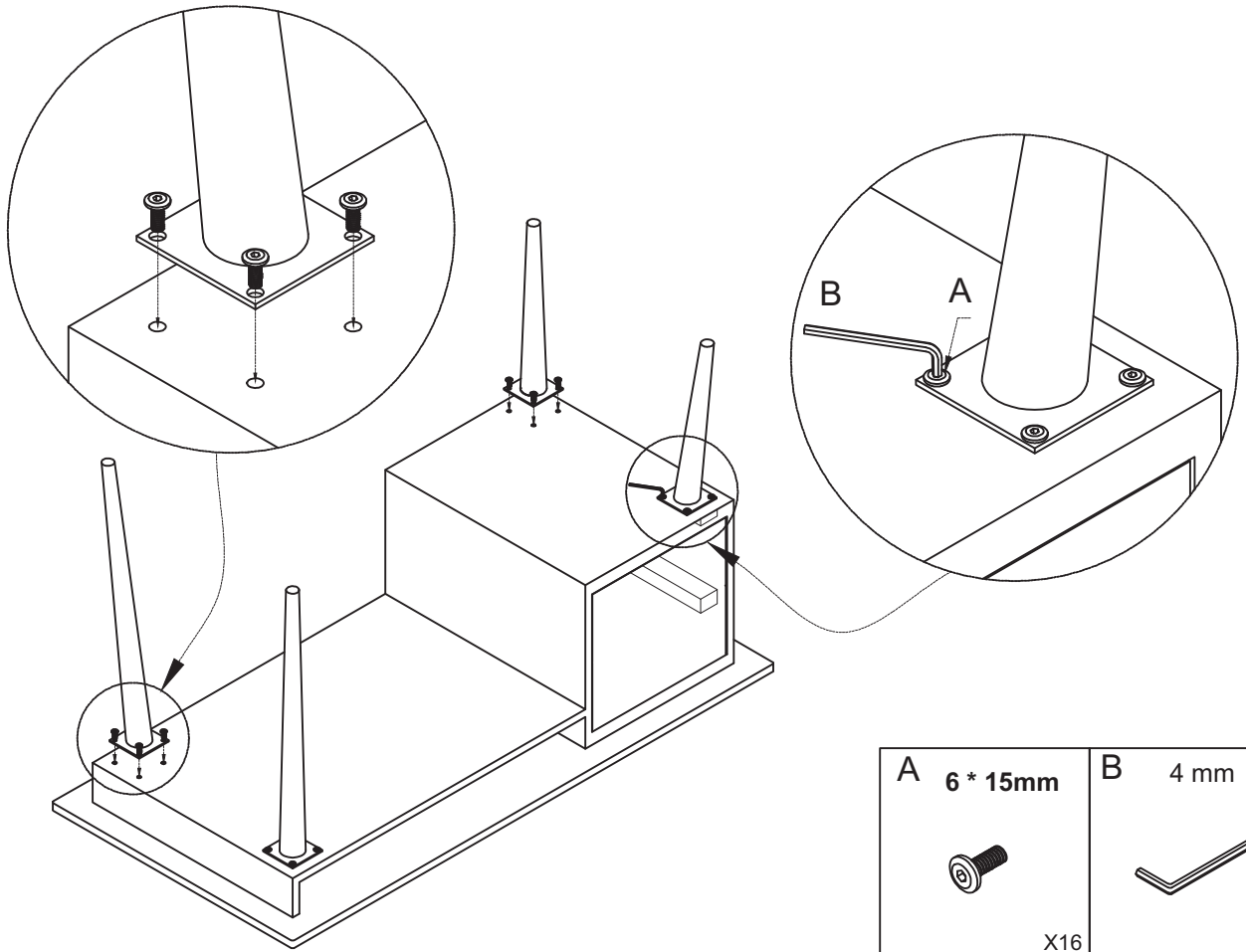

④

