

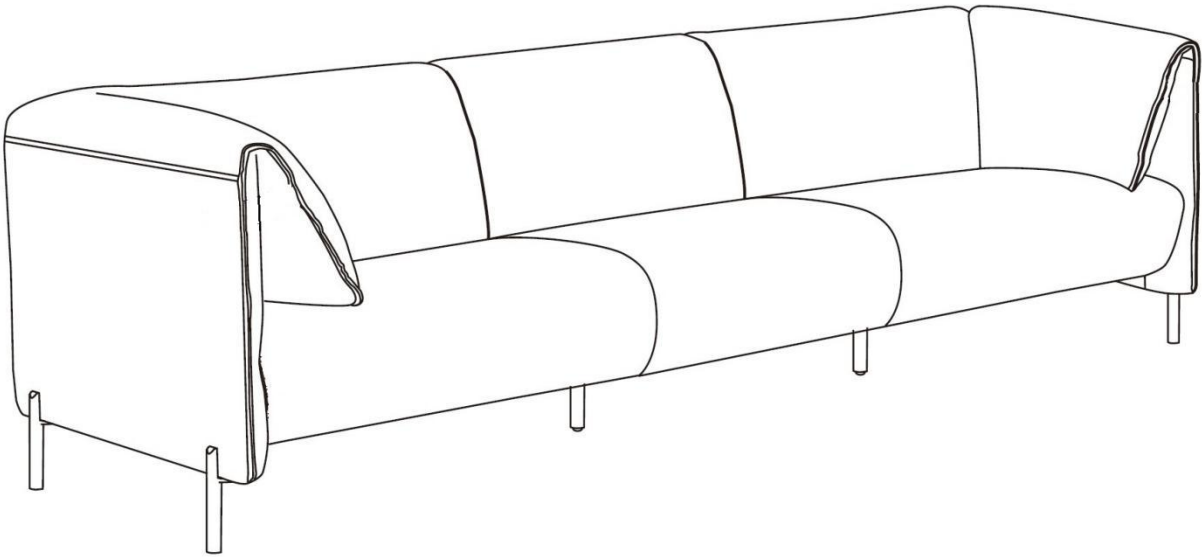

TODD





188550/188551/188552

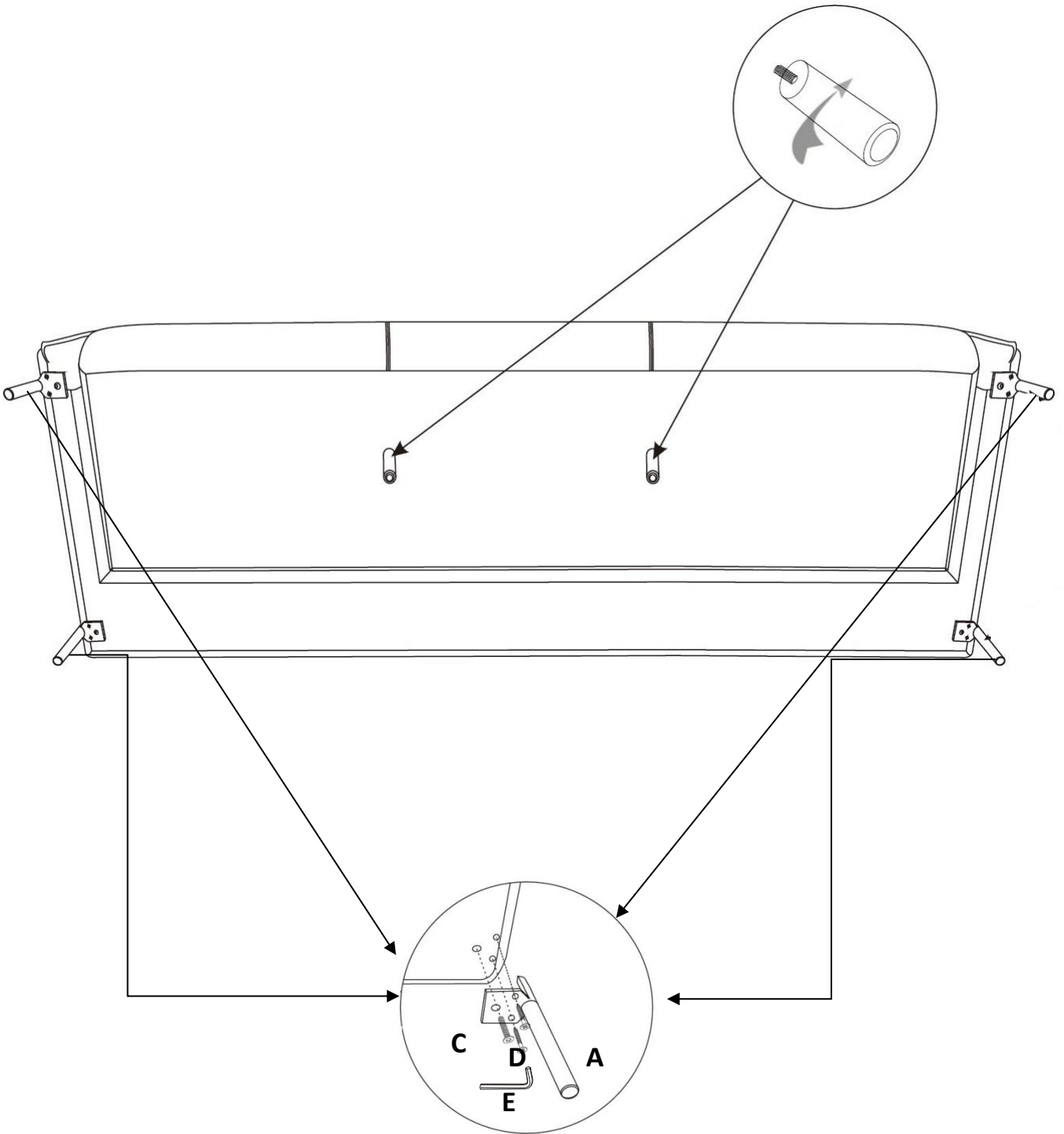

 10 MIN	
---	---

B



<p>A</p>  <p>(140MM)</p> <p>x 4</p>	<p>B</p>  <p>(Φ32MM x170MM)</p> <p>x 2</p>	<p>C</p>  <p>(Φ10MM x 30MM)</p> <p>x 4</p>	<p>D</p>  <p>(Φ5MM x 50MM)</p> <p>x 8</p>	<p>E</p>  <p>x 1</p>
---	--	--	---	--