

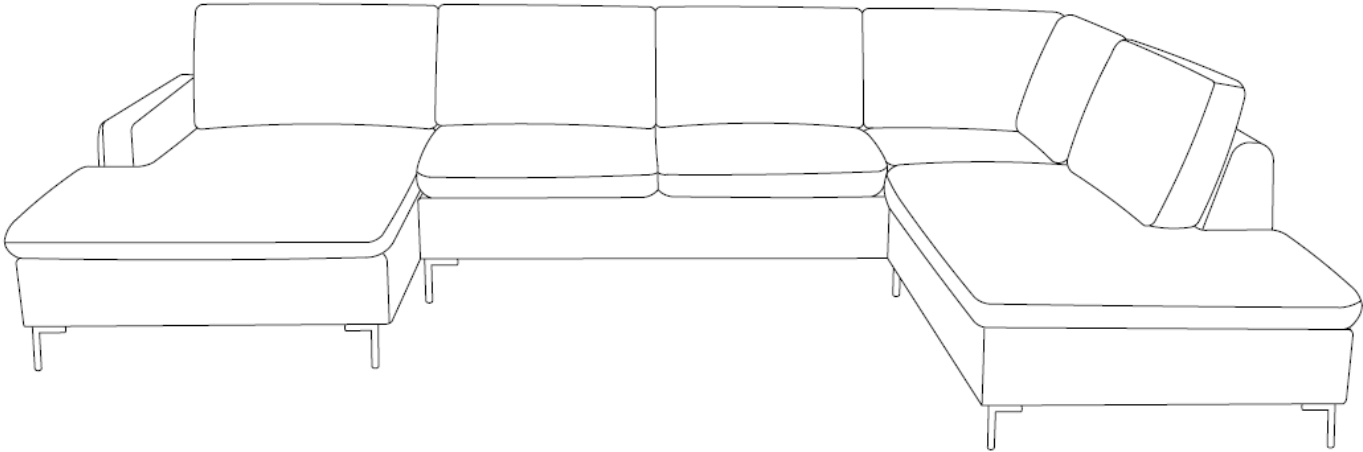



# CITY

147 526, 147 527  
174 755, 183 854  
183 858, 183 892



 45 MIN		
---	---	---

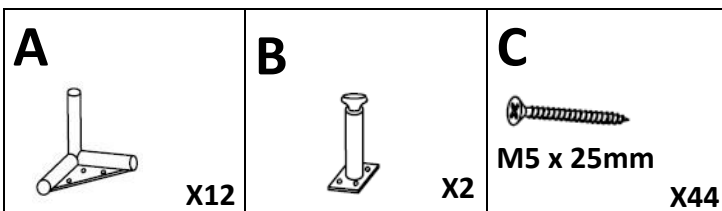
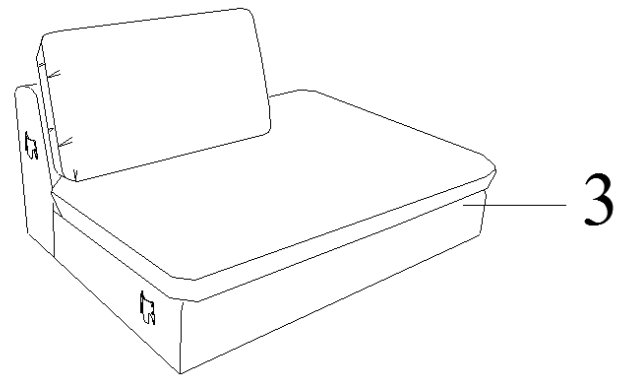
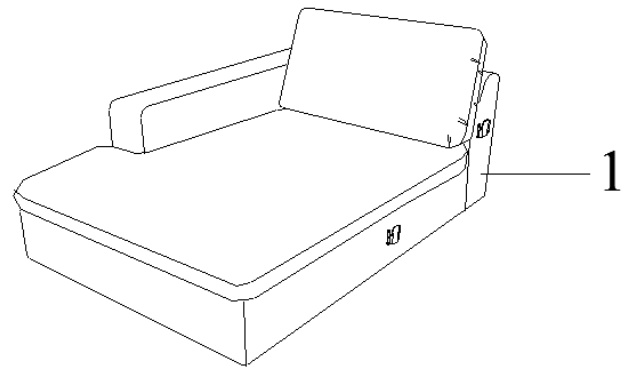
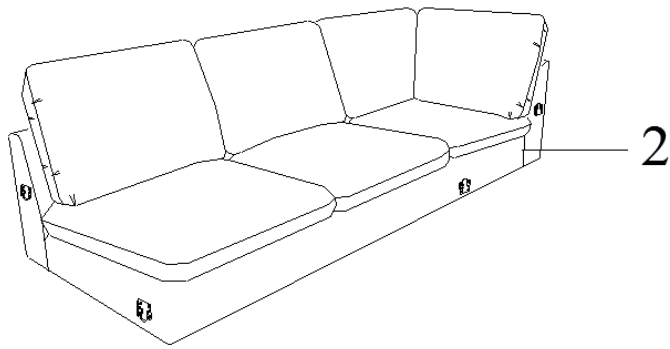

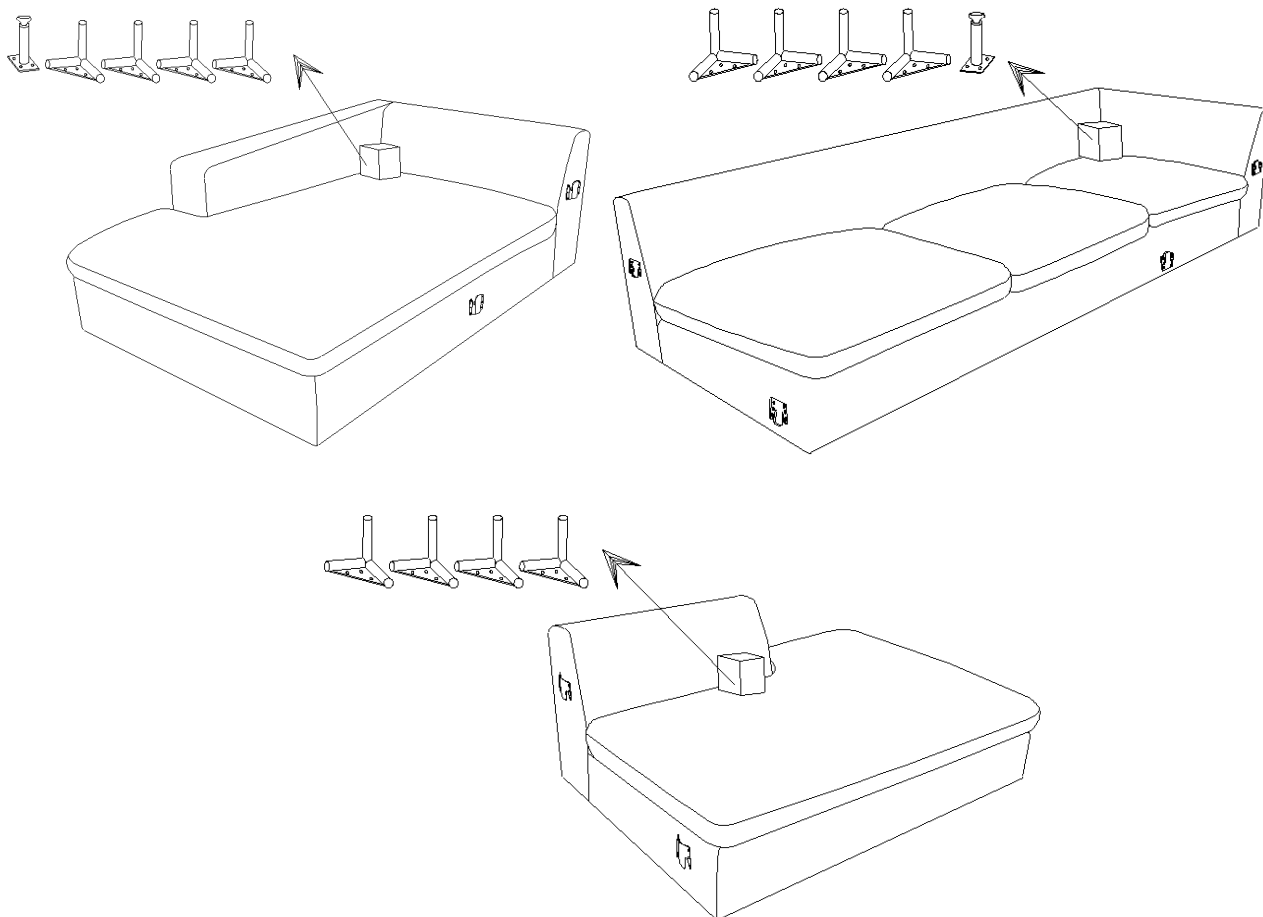

①



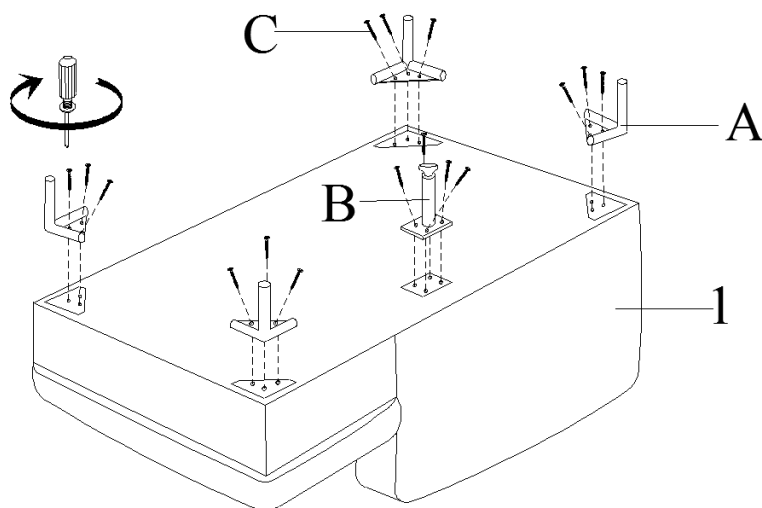

②

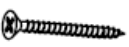

<b>A</b>  X4	<b>B</b>  X1	<b>C</b>  M5 x 25mm X16
---	---	---

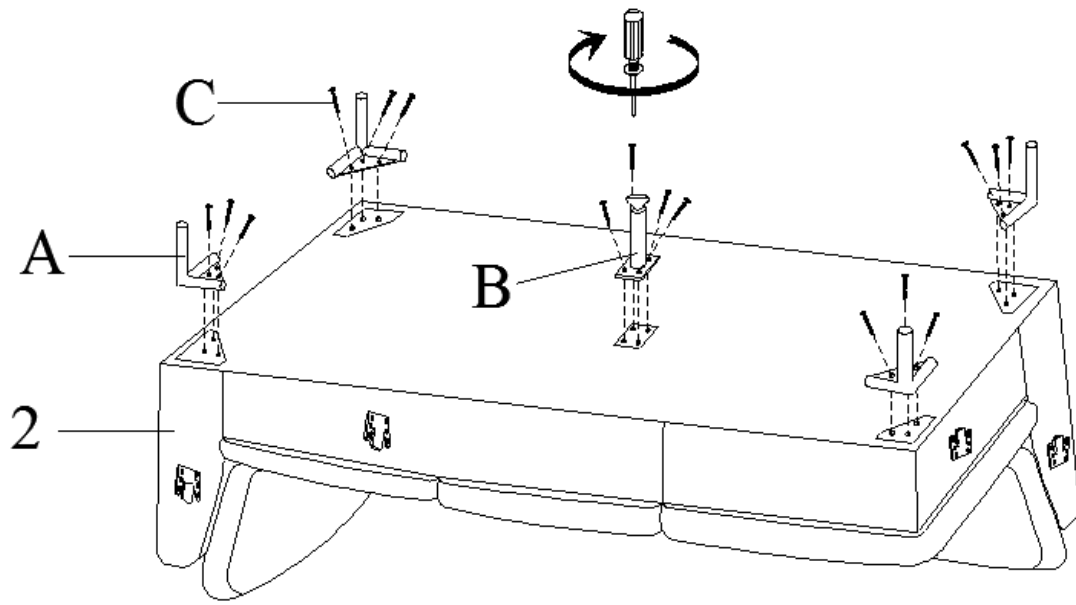
③

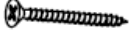

<b>A</b>  X4	<b>B</b>  X1	<b>C</b>  M5 x 25mm X16
---	---	---

④

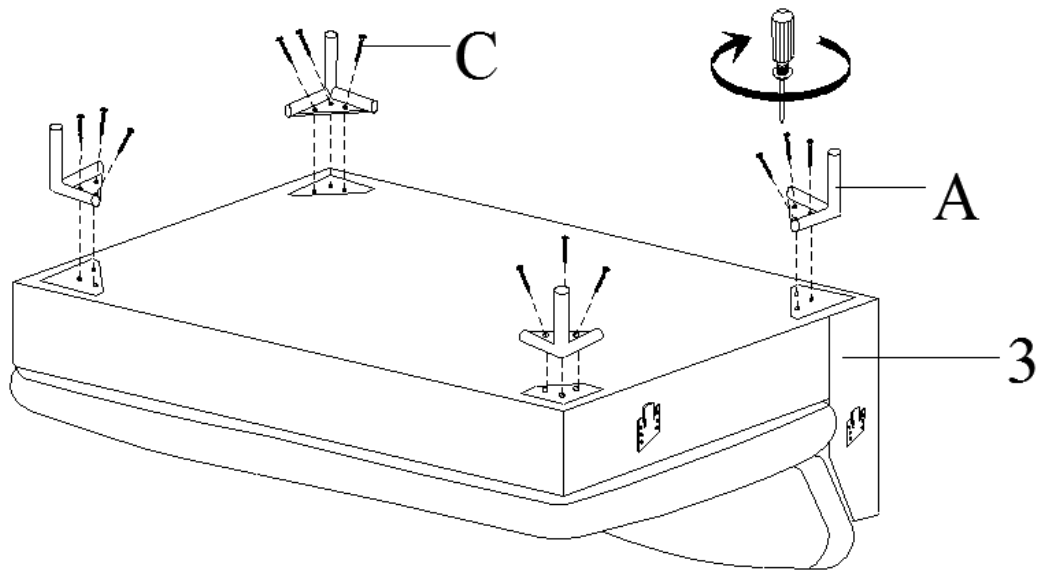

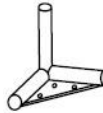
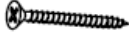
<b>A</b>  X4	<b>C</b>  M5 x 25mm X12
---	---

⑤

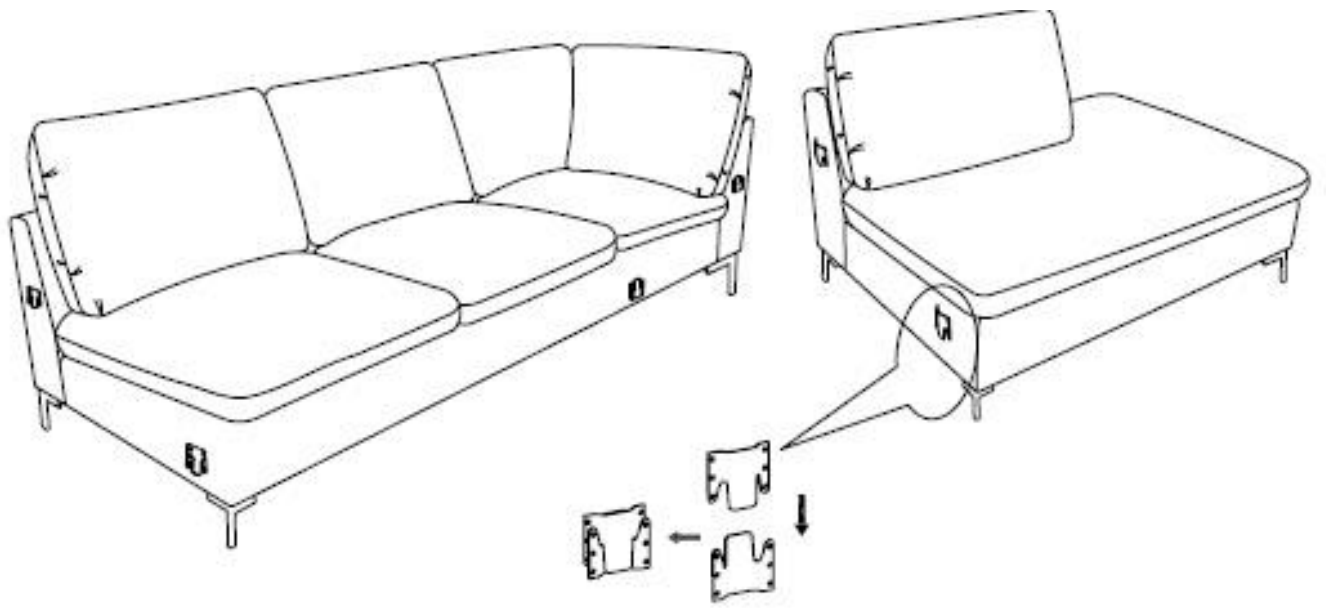

⑥

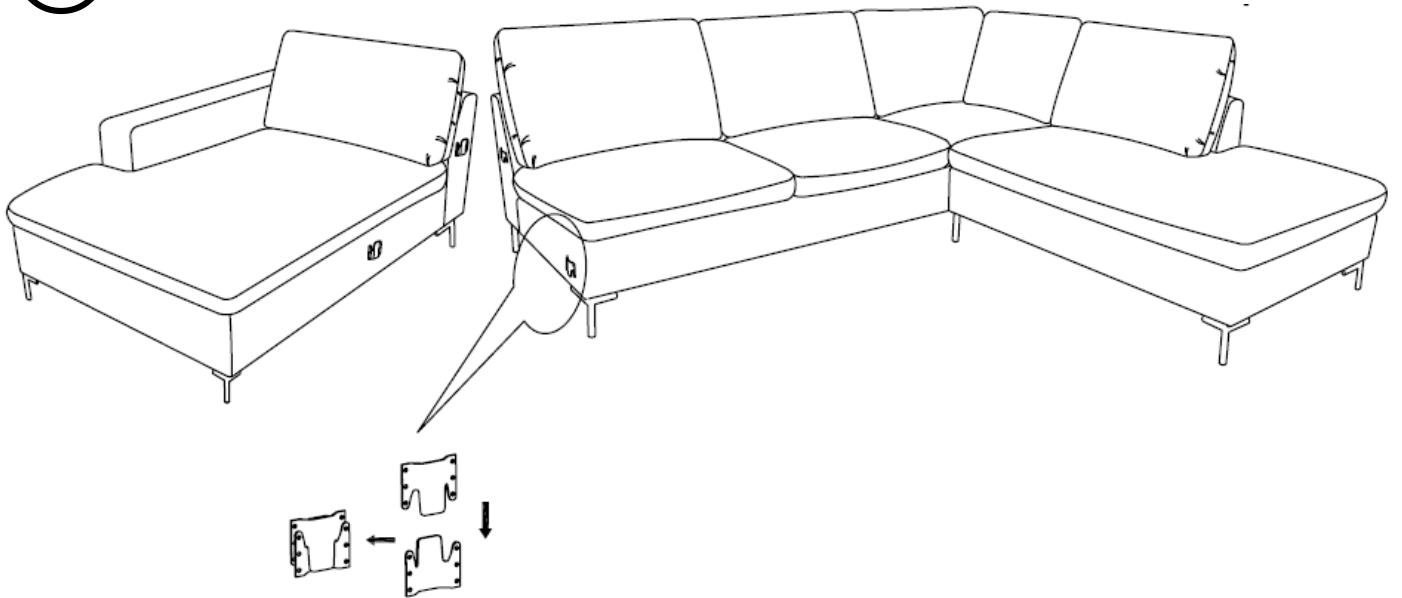

7

