

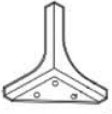











<p>A</p>  <p>X4</p>	<p>B</p>  <p>X1</p>	<p>C</p>  <p>M8x30mm X12</p>	<p>D</p>  <p>X12</p>	<p>E</p>  <p>X12</p>	<p>F</p>  <p>X1</p>
---	---	--	--	---	---

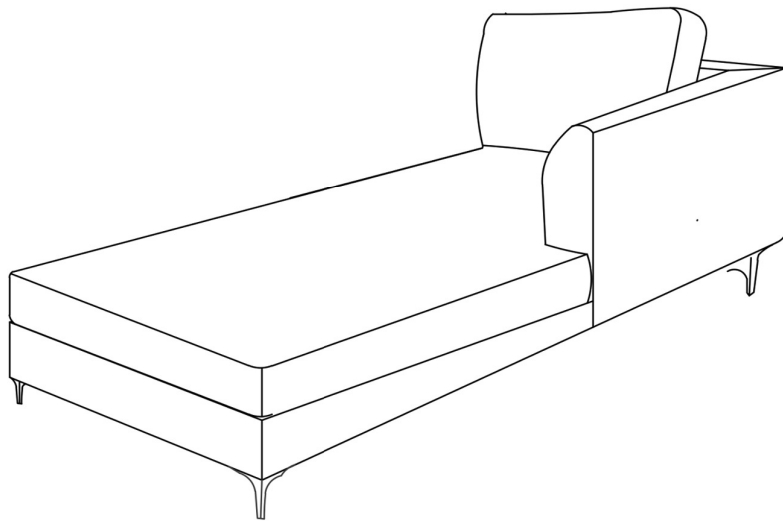
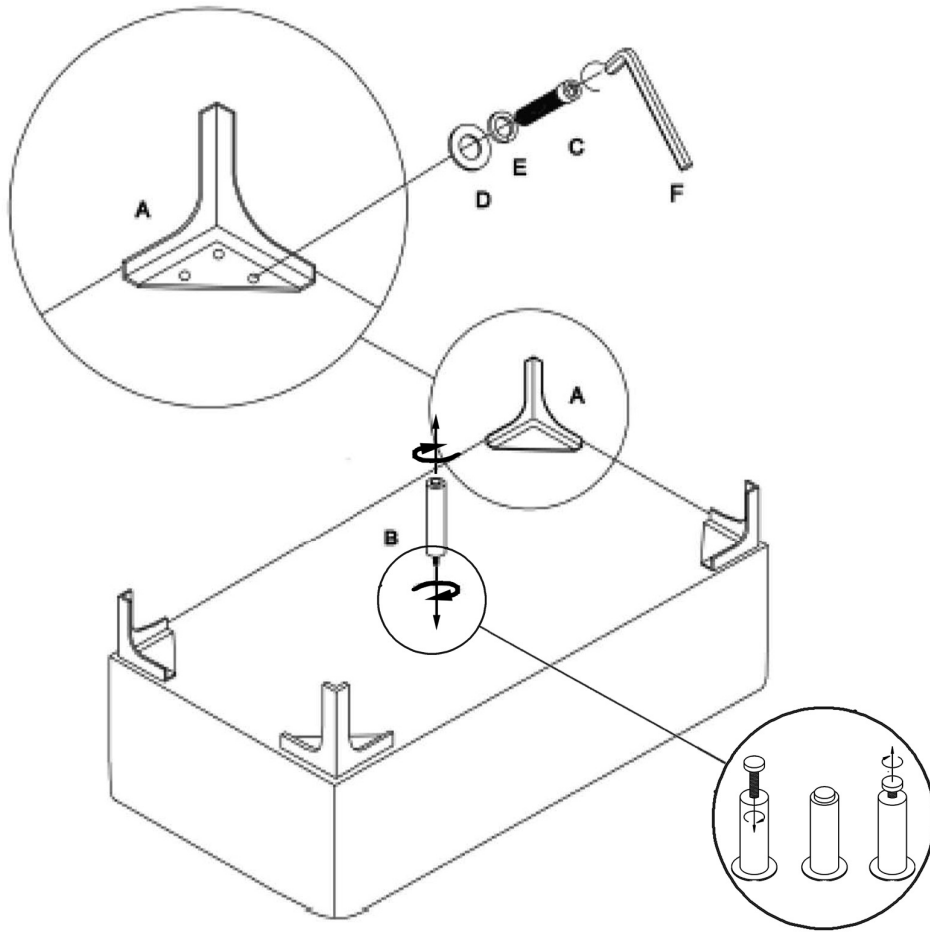

<p>A</p>  <p>X4</p>	<p>B</p>  <p>X1</p>	<p>C</p>  <p>M8x30mm X12</p>	<p>D</p>  <p>X12</p>	<p>E</p>  <p>X12</p>	<p>F</p>  <p>X1</p>
---	---	--	--	---	---

