

166096/166101/187996/183885/
183916

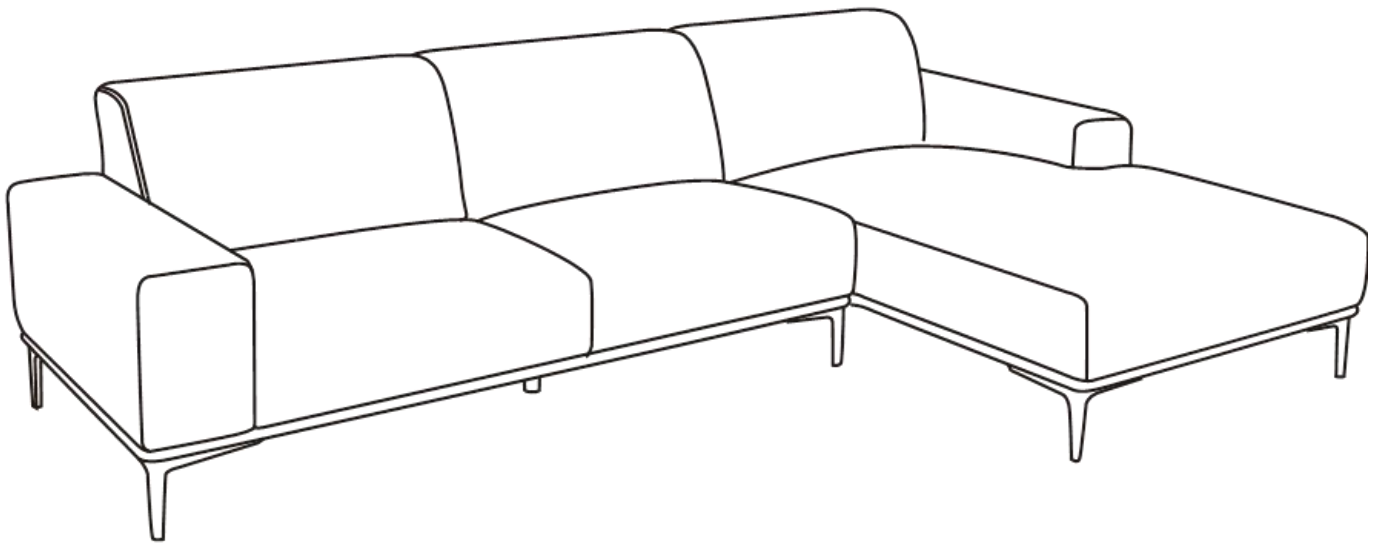





10 MIN

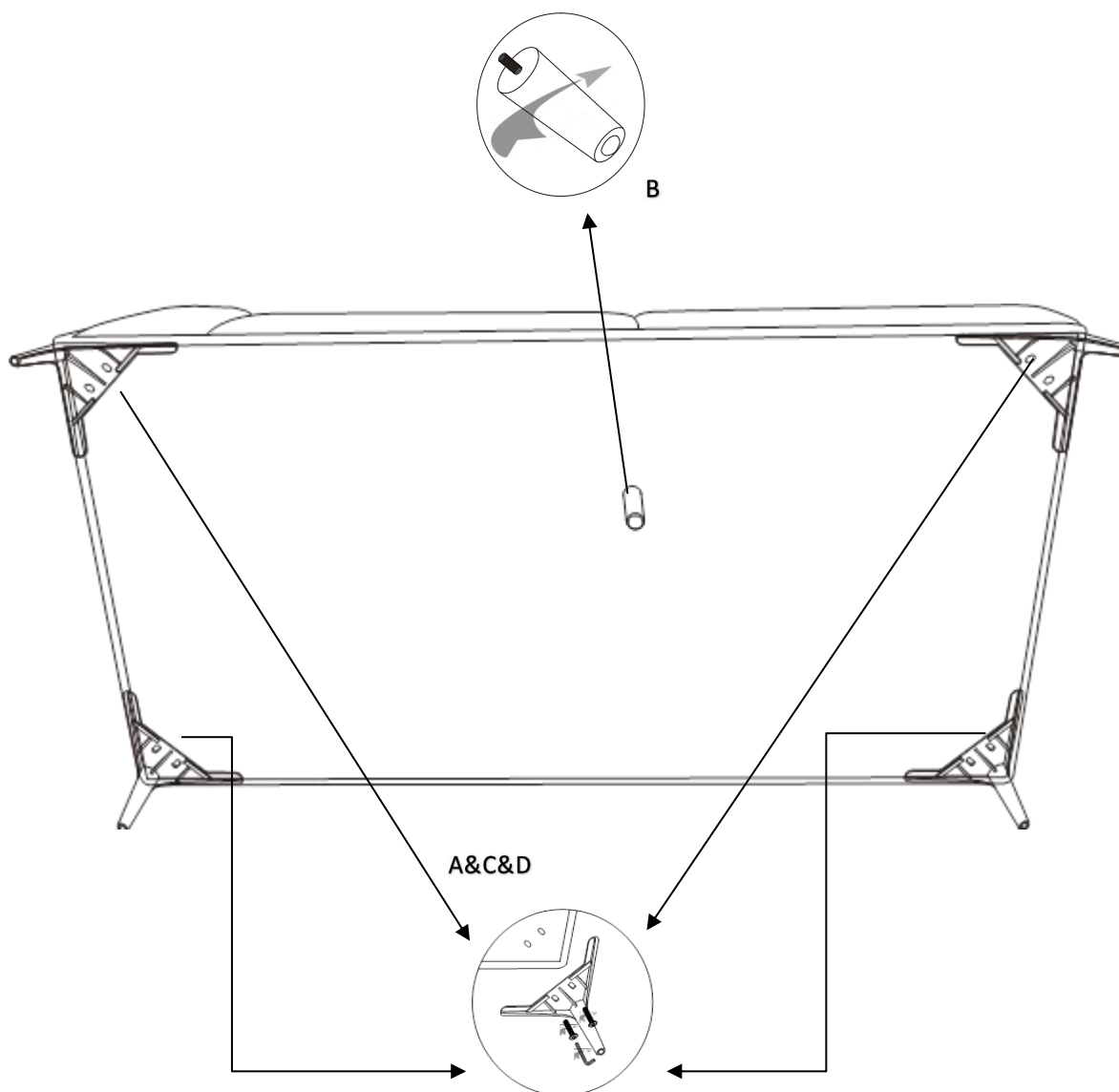
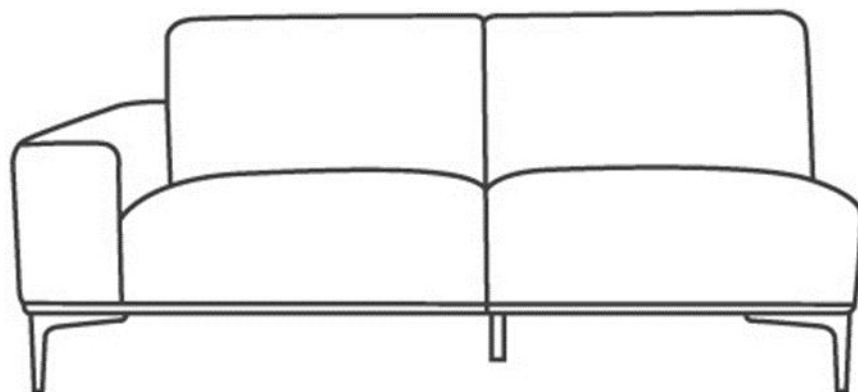





1

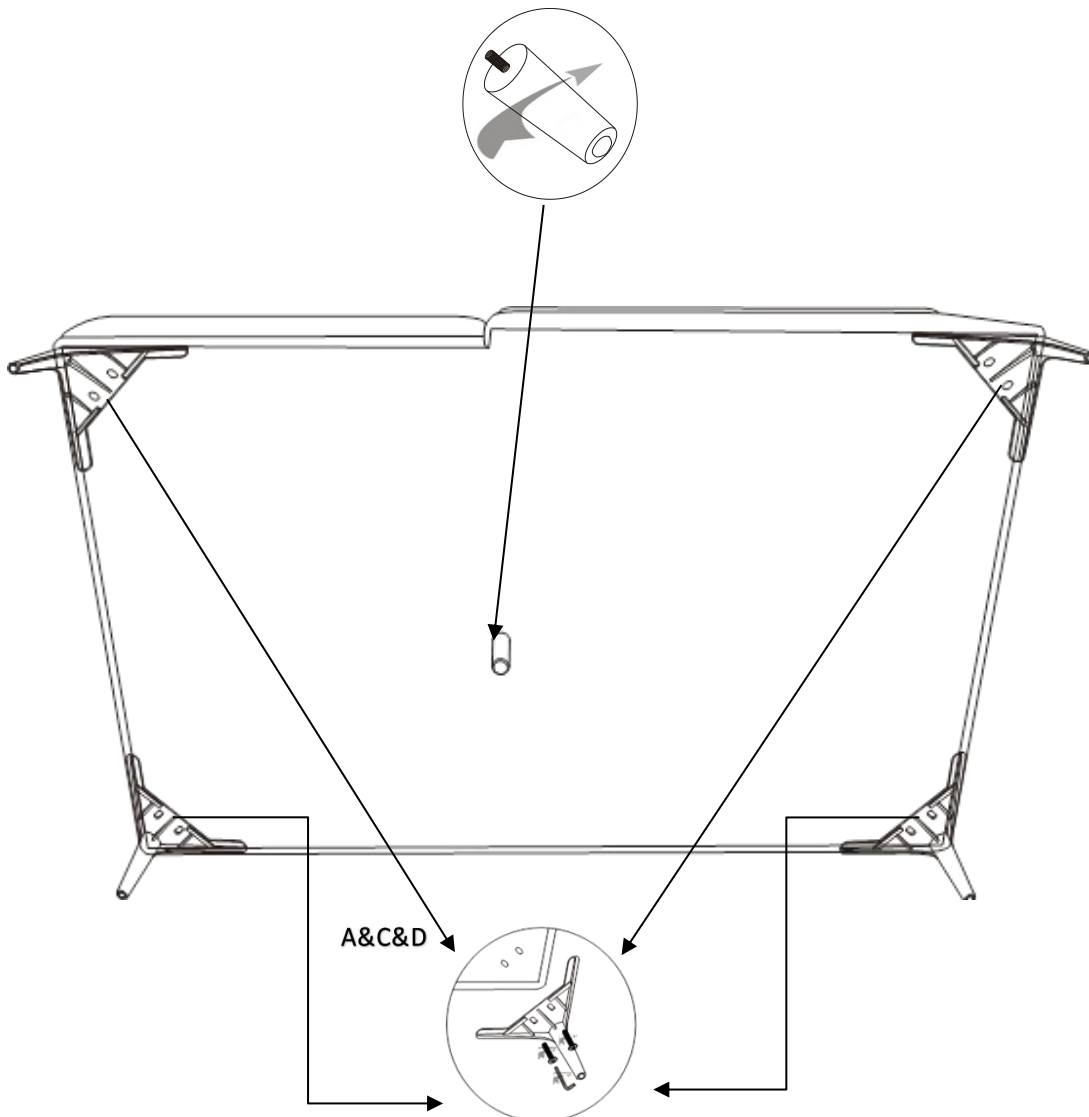
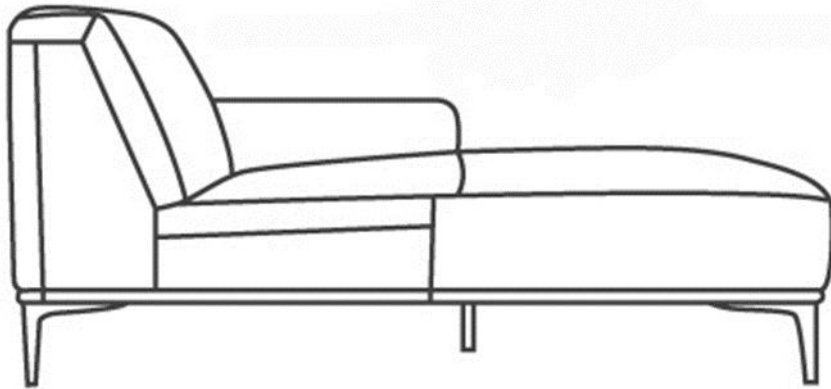

<p>A</p>  <p>(180MM)</p> <p>X4</p>	<p>B</p>  <p>(Φ32MM x170MM)</p> <p>x 1</p>	<p>C</p>  <p>(Φ10MM x 30MM)</p> <p>x 8</p>	<p>D</p>  <p>x 1</p>
--	--	--	--

2

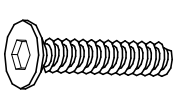

A  (180MM) x4	B  (Φ32MM x170MM) x 1	C  (Φ10MM x 30MM) x 8	D  x 1
--	--	--	--

3

