

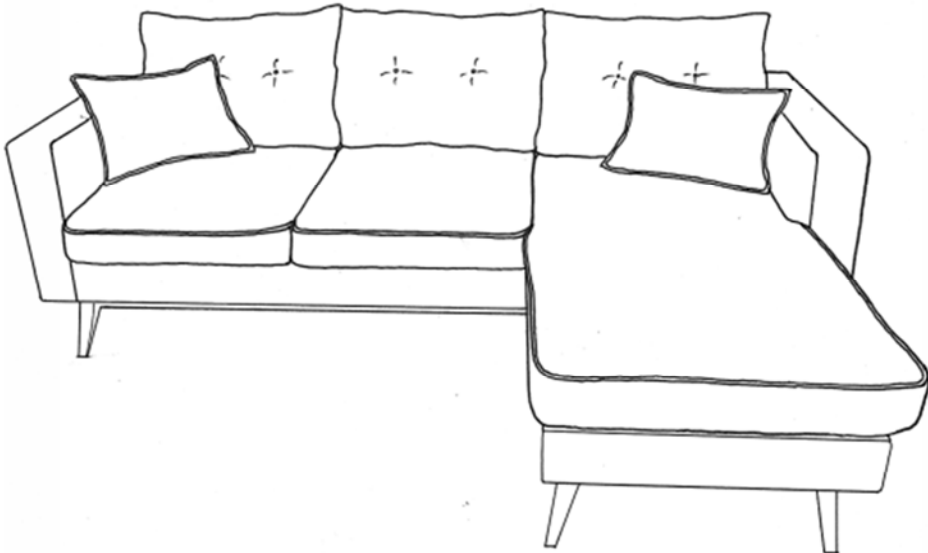

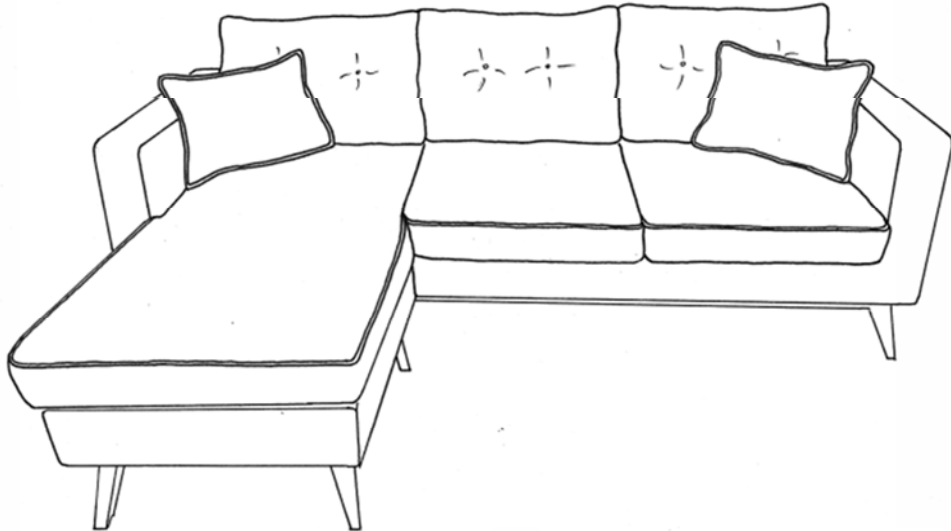





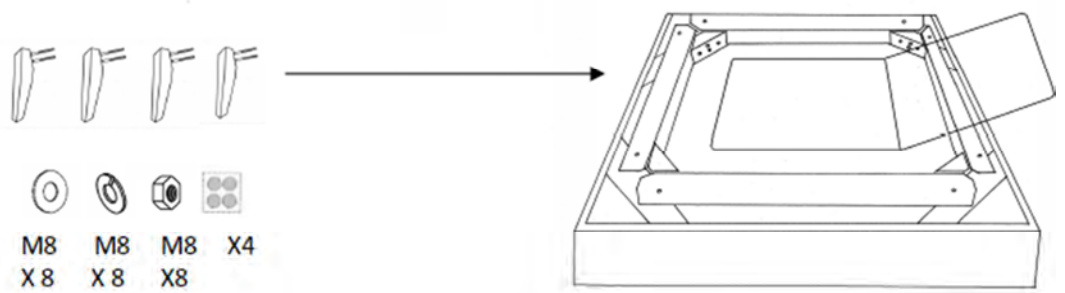
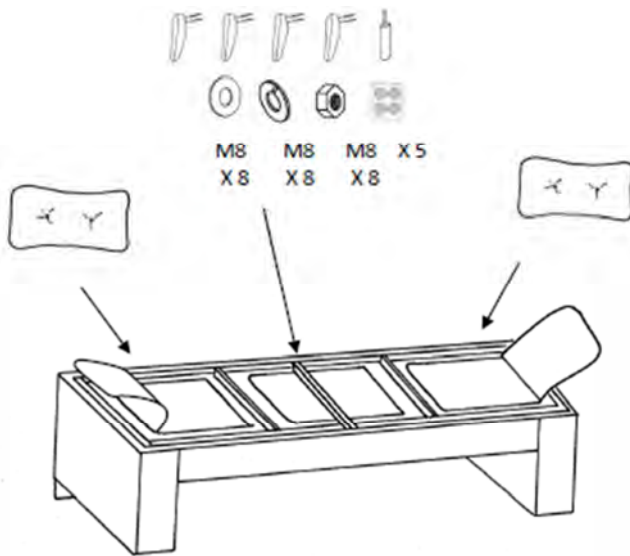
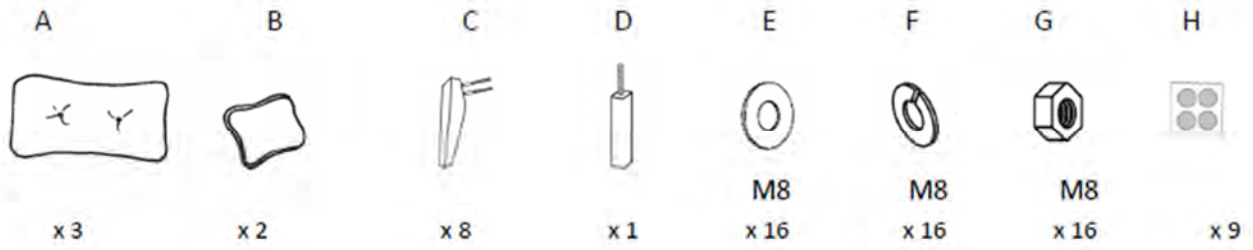

BROOKE

**166163/166171/174742/
185268/185269/185276/
186340/186381**









 30 MIN		
---	---	---

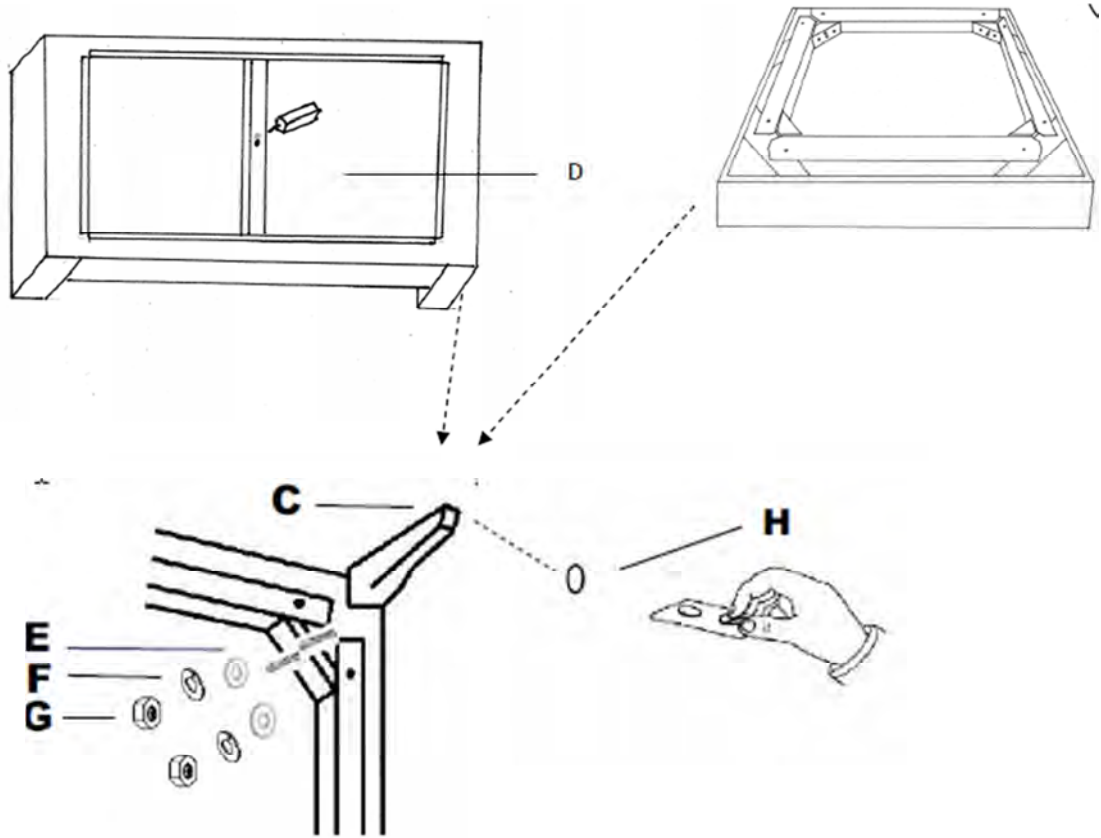

C  x8	D  x1	E  M8 x16	F  M8 x16	G  M8 x16	H  x9
---	---	--	--	---	---

①

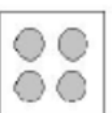

C  X8	D  X1	E  M8 X16	F  M8 16	G  M8 X16	H  X9
--	--	--	---	--	--

