

FR - IMPORTANT - ACONSERVER POUR UNE UTILISATION ULTÉRIEURE - A LIRE ATTENTIVEMENT.

Ref: 186687 ENDOUME

- Pour usage domestique - Poids maximum : 360KG - Distributeur : MAISONS DU MONDE Le portereau 44120 Vertou - FRANCE

EN - IMPORTANT - RETAIN FOR FUTURE REFERENCE - PLEASE READ CAREFULLY.

Ref: 186687 ENDOUME

-For domestic use - Maximum weight: 360KG -Distributor: MAISONS

DU MONDE Le portereau 44120 Vertou – France

IT - IMPORTANTE - DA CONSERVARE PER UN FUTURO RIFERIMENTO - LEGGERE ATTENTAMENTE.

Rifl: 186687 ENDOUME

- Per uso domestico- Peso massimo: 360KG - Distributore: MAISONS DU MONDE Le portereau 44120 Vertou - FRANCE

NL - BELANGRIJK - TE BEWAREN VOOR LATERE RAADPLEGING - AANDACHTIG TE LEZEN.

Ref: 186687 ENDOUME

-Voor huishoudelijk gebruik - Maksimal vægt: 360KG - Distributør : MAISONS DU MONDE Le portereau 44120 Vertou - FRANCE

CAT - IMPORTANT - CONSERVEU AQUEST MANUAL D'INSTRUCCIONS PER A FUTURES CONSULTES - LLEGIU LES INSTRUCCIONS ATENTAMENT.

Ref: 186687 ENDOUME

- Per a ús domèstic - Pes màxim : 360KG - Distribuïdor: MAISONS DU MONDE Le portereau 44120 Vertou - FRANCE

**PT - IMPORTANTE - CONSERVAR PARA REFERÊNCIA FUTURA -
LER ATENTAMENTE.**

Ref: 186687 ENDOUME

- *Para uso doméstico -Peso máximo: 360KG - Distribuidor:
MAISONS DU MONDE Le portereau 44120 Vertou - FRANCE*

**DE - WICHTIG - HEBEN SIE DIESE WARNHINWEISE BITTE AUF,
FALLS SIE IRGENDWANN NOCH EIN- MAL ETWAS NACHLESEN
AUFMERKSAM DURCHMÜSSEN - BITTE LESEN SIE SIE.**

Art-Nr.: 186687 ENDOUME





- *Für Hausgebrauch -Höchstgewicht: 360KG - Händler:
MAISONS DU
MONDE Le portereau 44120 Vertou – FRANCE*

– هابتتاب اهتءارق بجي لبقتسملا يف اهتءجارم بلا جاتحت كلعل
- AR - قرشةنملا اهةذظهب لاطمفت–

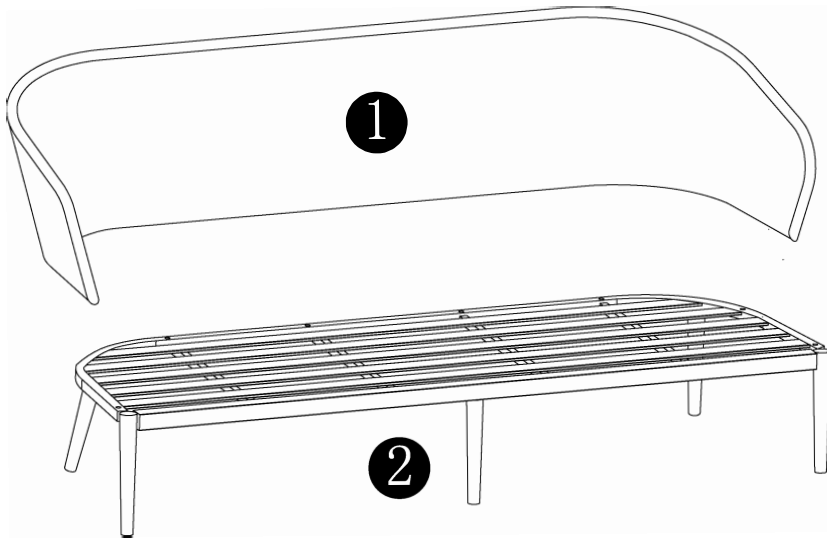
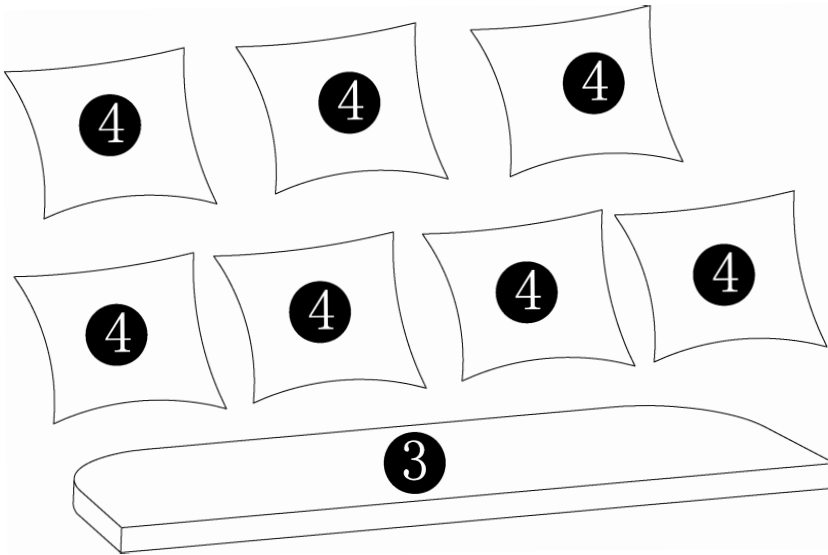
186687 ENDOUME :Ref:

- *360KG: أقصى وزن للاستخدام المنزلي - MAISONS DU MONDE Le
44120 Vertou – France*

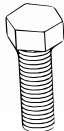

<p>A</p>  <p>X1</p>	<p>B</p>  <p>X6</p>	<p>C</p>  <p>X6</p>	<p>D</p>  <p>X6</p>	<p>E</p>  <p>X6</p>
--	--	--	---	--

