



|   |   |   |
|---|---|---|
|  20<br>MIN |  |  |
|---|---|---|



Ax4

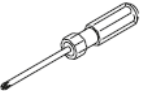
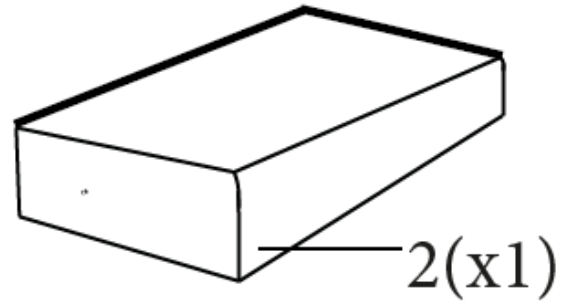
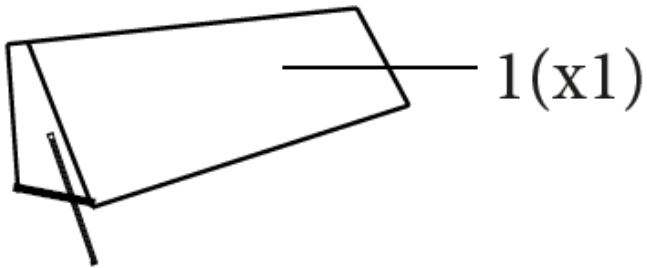

Bx4



Cx4



Dx4









Ex4



Fx4





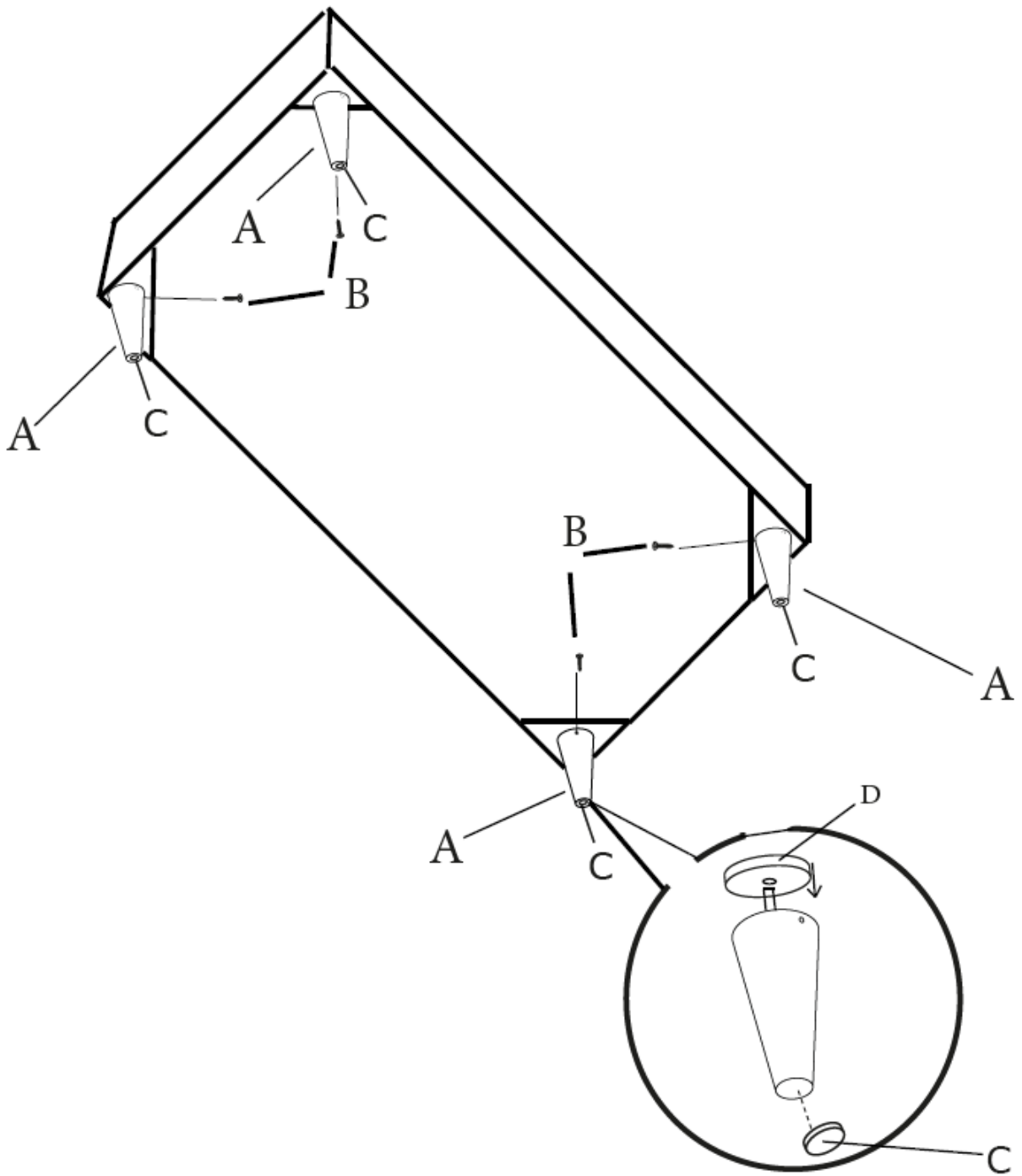

Gx2

|   |   |   |   |  |   |   |
|---|---|---|---|--|---|---|
| A   | B   | C   | D   | E  | F   | G   |
|  |  |  |  |  |  |  |
| X4  | X4  | X4  | X4  | X4   | X4  | X2  |



①

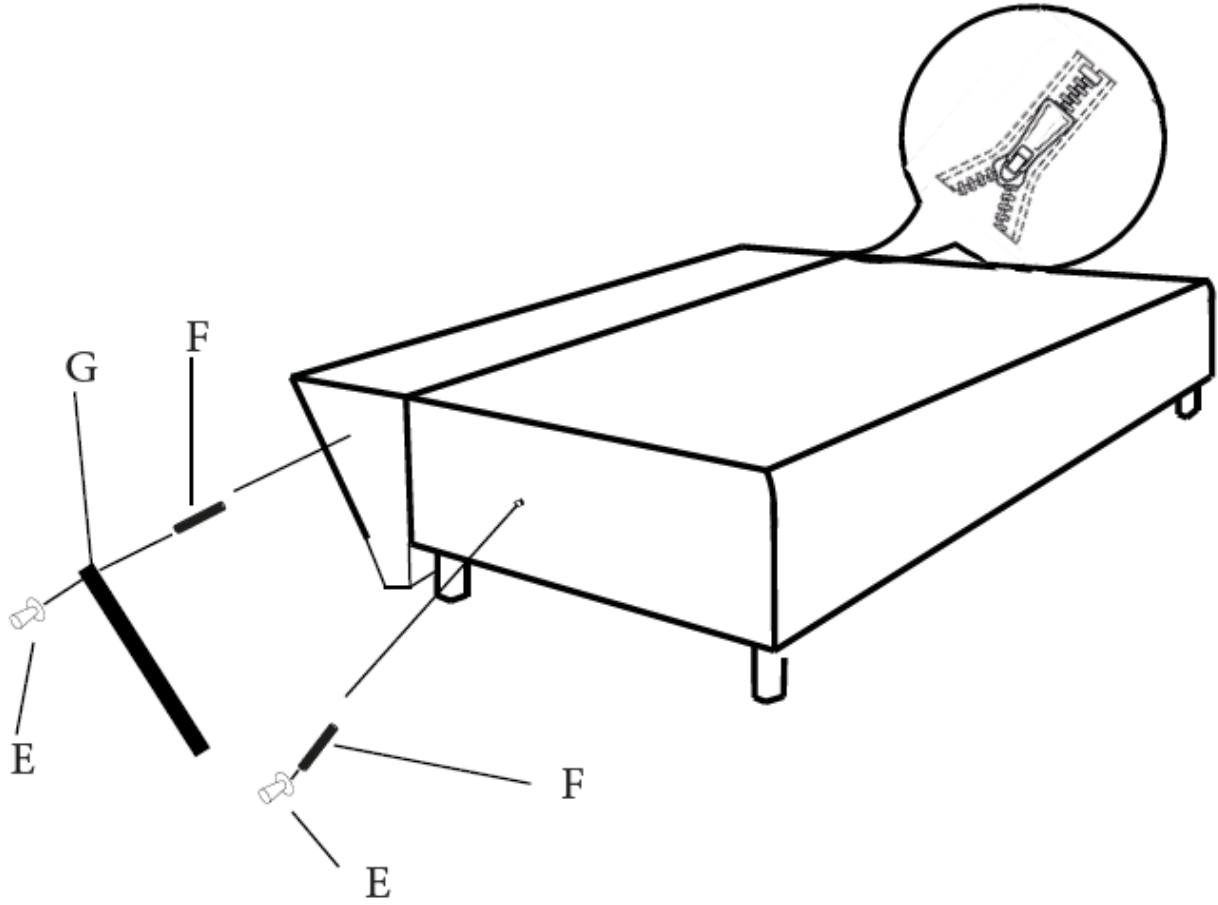

|  |  |  |  |
|--|--|--|--|
| A<br><br>X4 | B<br><br>X4 | C<br><br>X4 | D<br><br>X4 |
|--|--|--|--|

②



|  |  |  |
|--|--|--|
| E<br><br>X4 | F<br><br>X4 | G<br><br>X2 |
|--|--|--|

③

