

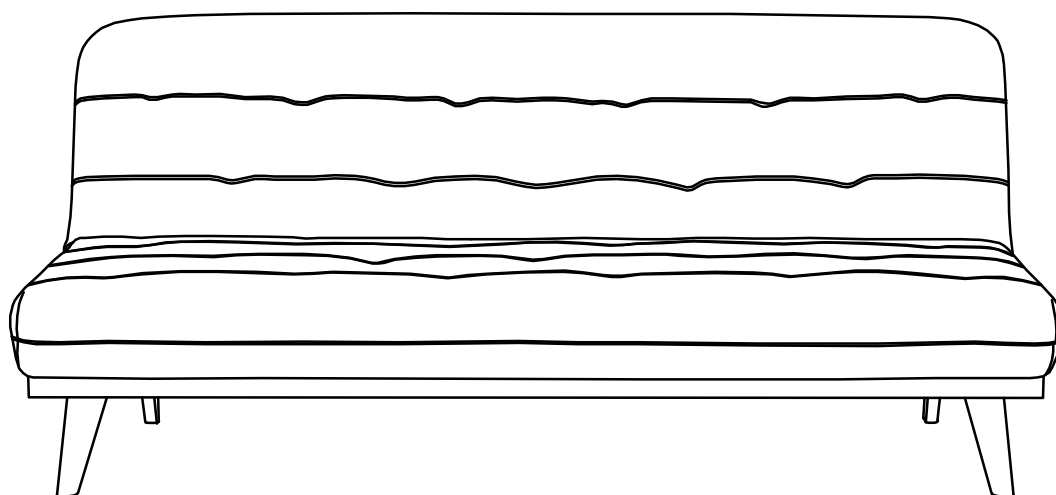

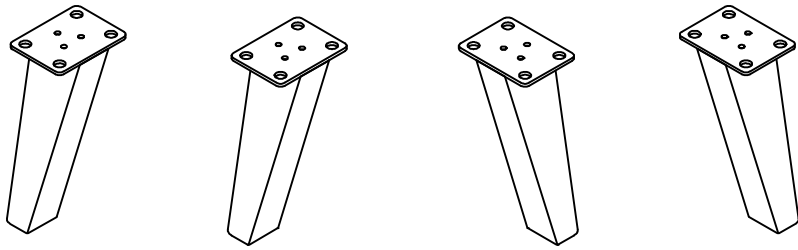

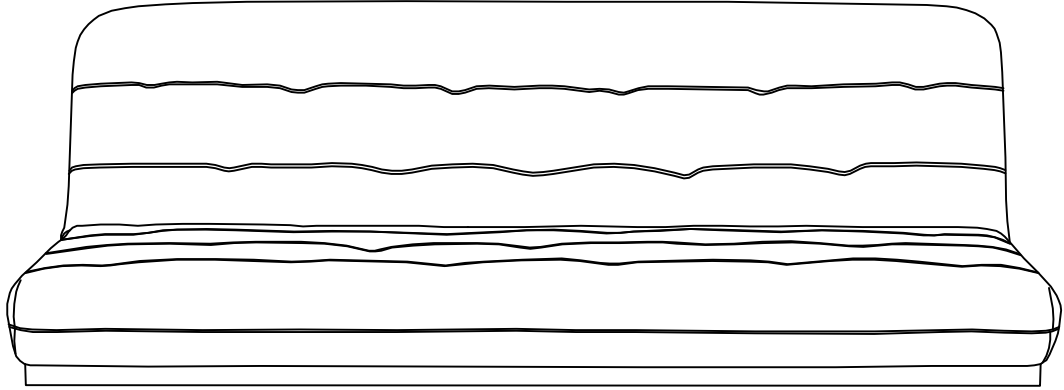

# DECLIK

186454/186455/  
186456





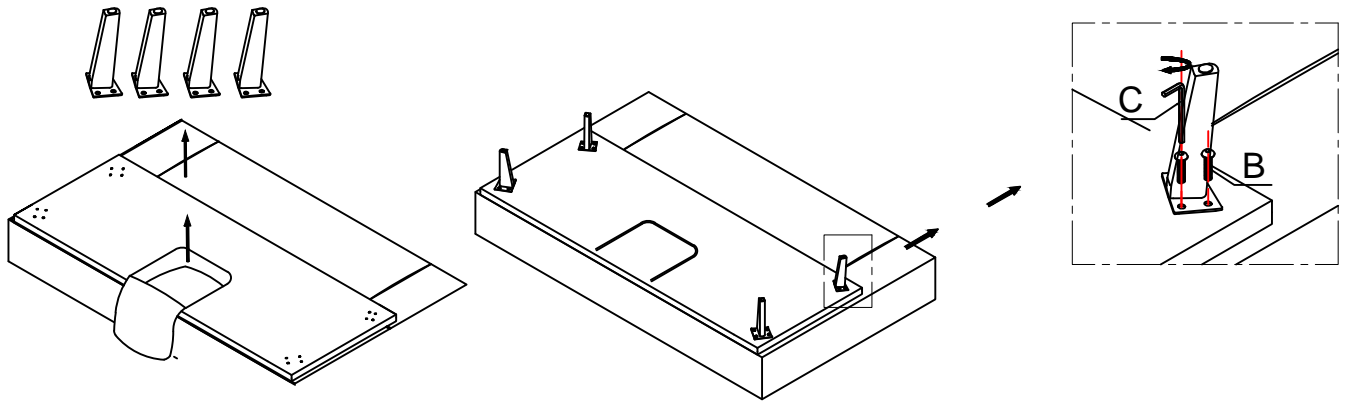

<b>A.</b>  <b>X 4</b>	<b>B.</b>  <b>X 1</b>	<b>C.</b>  <b>X 16</b>
--	--	--

1.



<p>A.</p>  <p>X 4</p>	<p>B.</p>  <p>X 1</p>	<p>C.</p>  <p>X 16</p>
--	--	---

2.

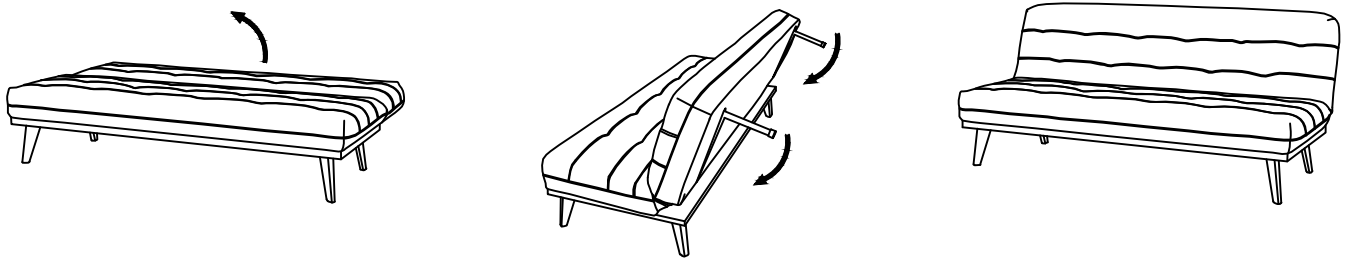

3.

