

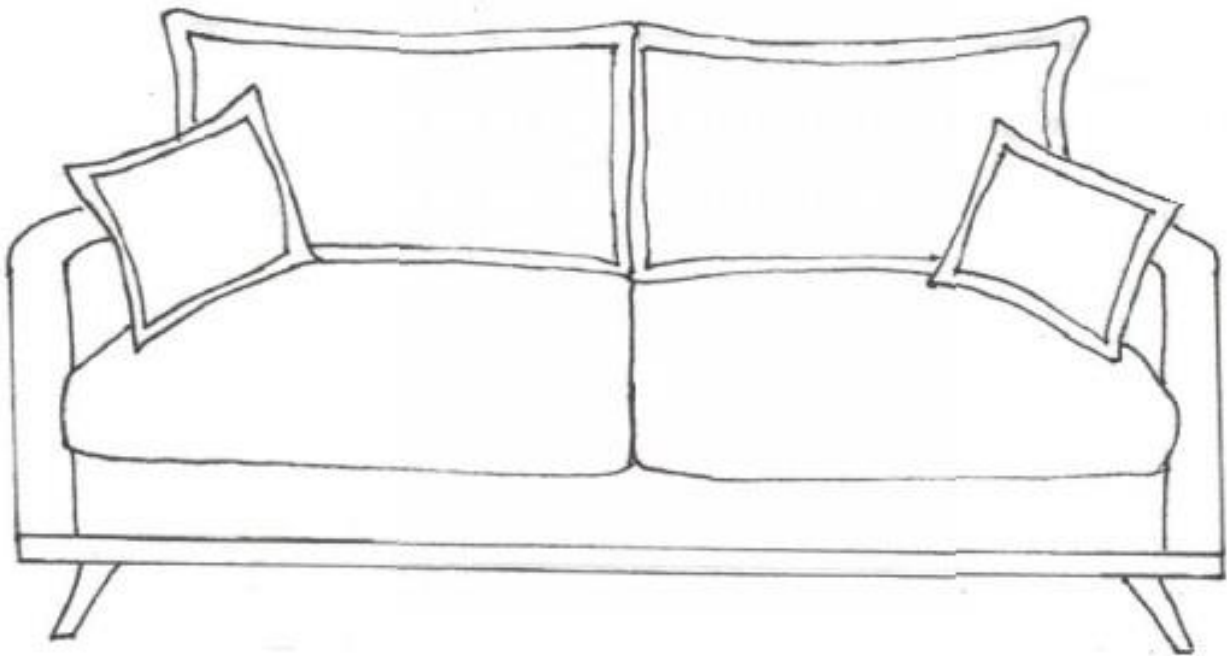

158824/158825/158829/

166348/166350

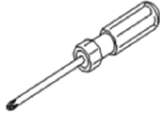

 30 MIN		
---	---	---

- A**
- B**
- C1**
- C2**
- D**
- E**
- F**

-
-
-
-
-
-
-

- X 2**
- X 2**
- X 2**
- X 2**
- X 4**
- X 5**
- X 10**
M6

- G**
- H**
- I**
- J**
- K**
- L**

-
-
-
-
-
-



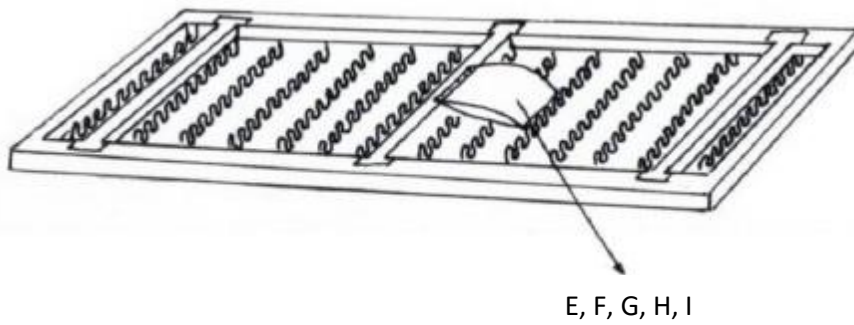
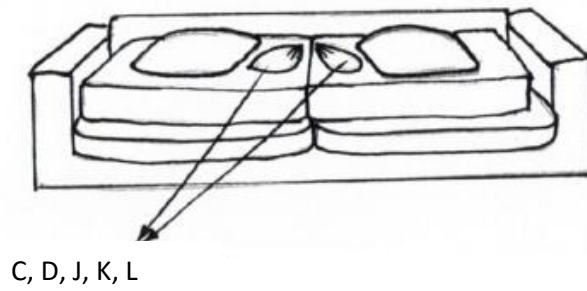

- X 10**
M6
- X 10**
M6
- X 10**
M6X35
- X 16**
4,5X35
- X 4**
50X3
- X 2**

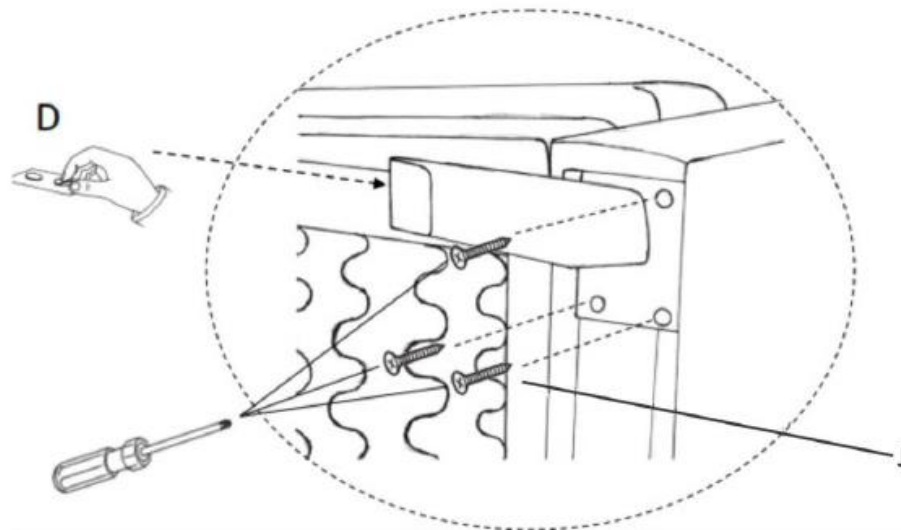
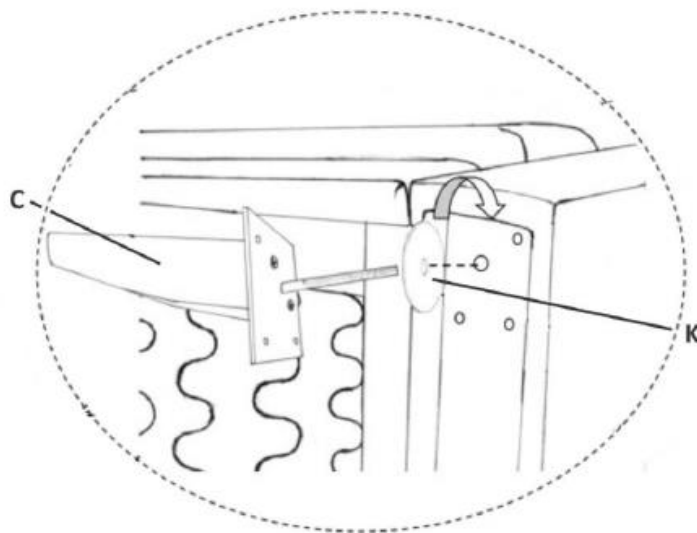
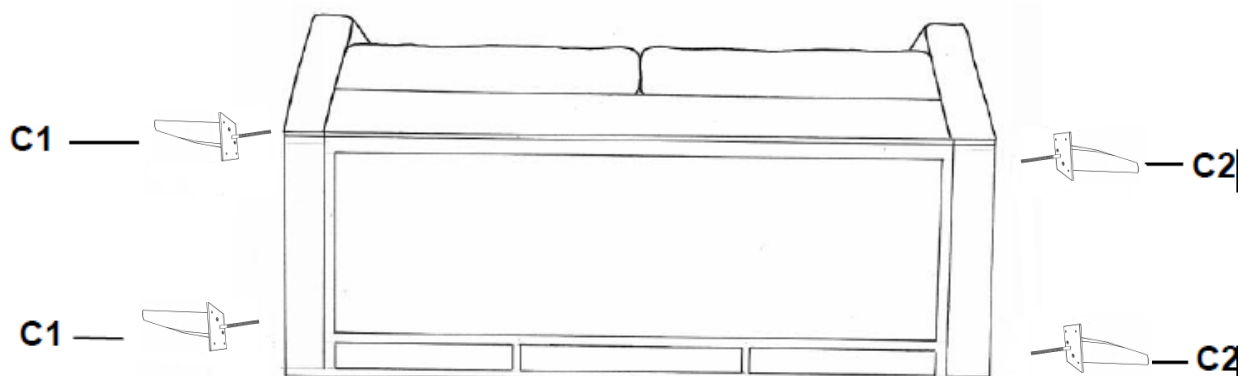

D	E	F	G	H	I	J	K	L
X4	X5	X10	X10	X10	X10	X16	X4	X2



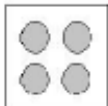



①

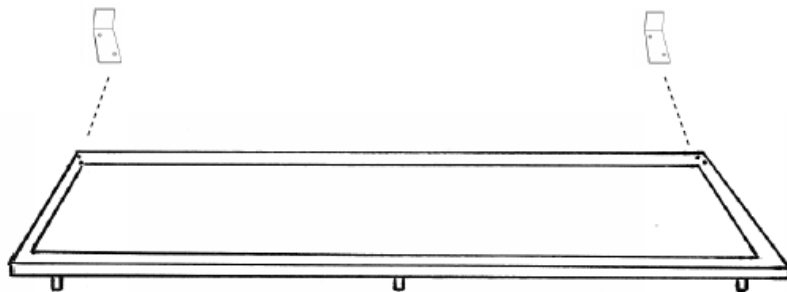
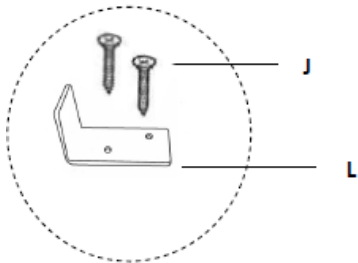
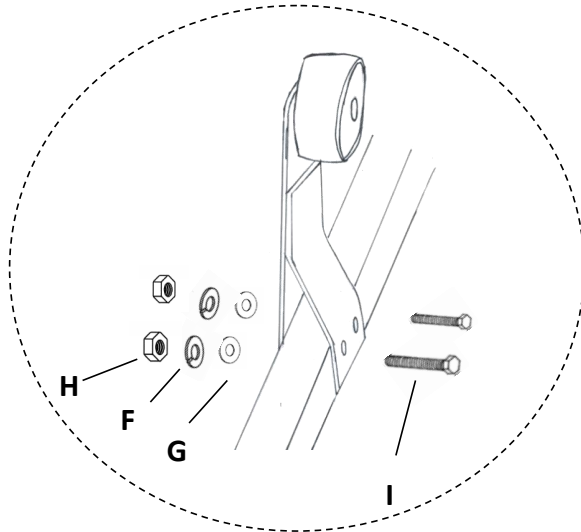
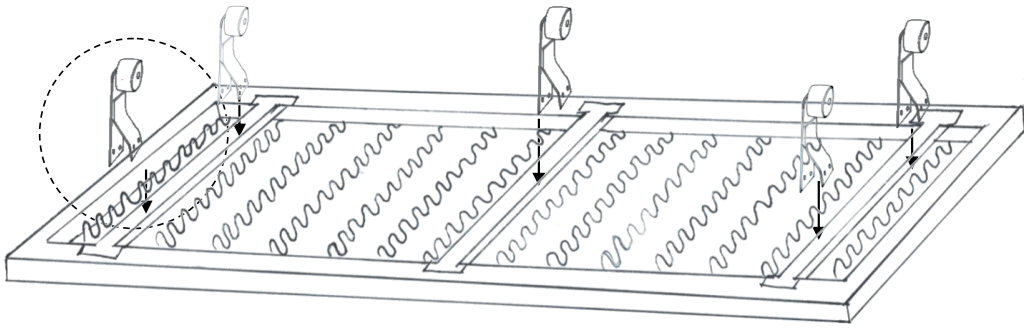

<p>C1</p>  <p>X2</p>	<p>C2</p>  <p>X2</p>	<p>D</p>  <p>X4</p>	<p>J</p>  <p>X12</p>	<p>K</p>  <p>X4</p>
---	---	--	---	--

2



<p>E</p>  <p>X 5</p>	<p>F</p>  <p>X 10</p>	<p>G</p>  <p>X 10</p>	<p>H</p>  <p>X 10</p>	<p>I</p>  <p>X10</p>	<p>J</p>  <p>X4</p>	<p>L</p>  <p>X2</p>
---	--	--	--	--	--	--

③

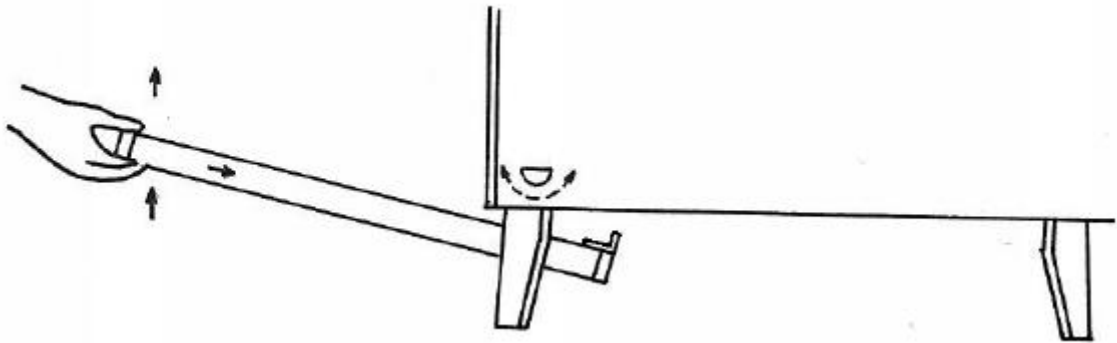
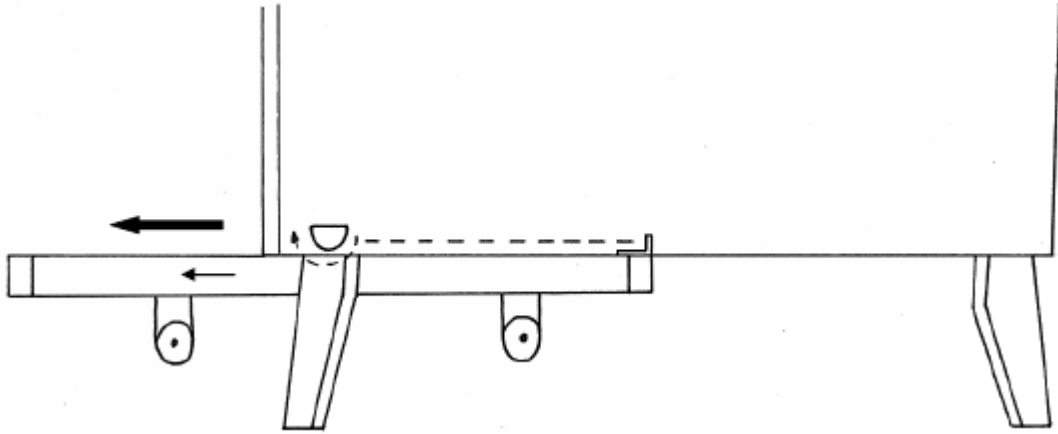

④

