

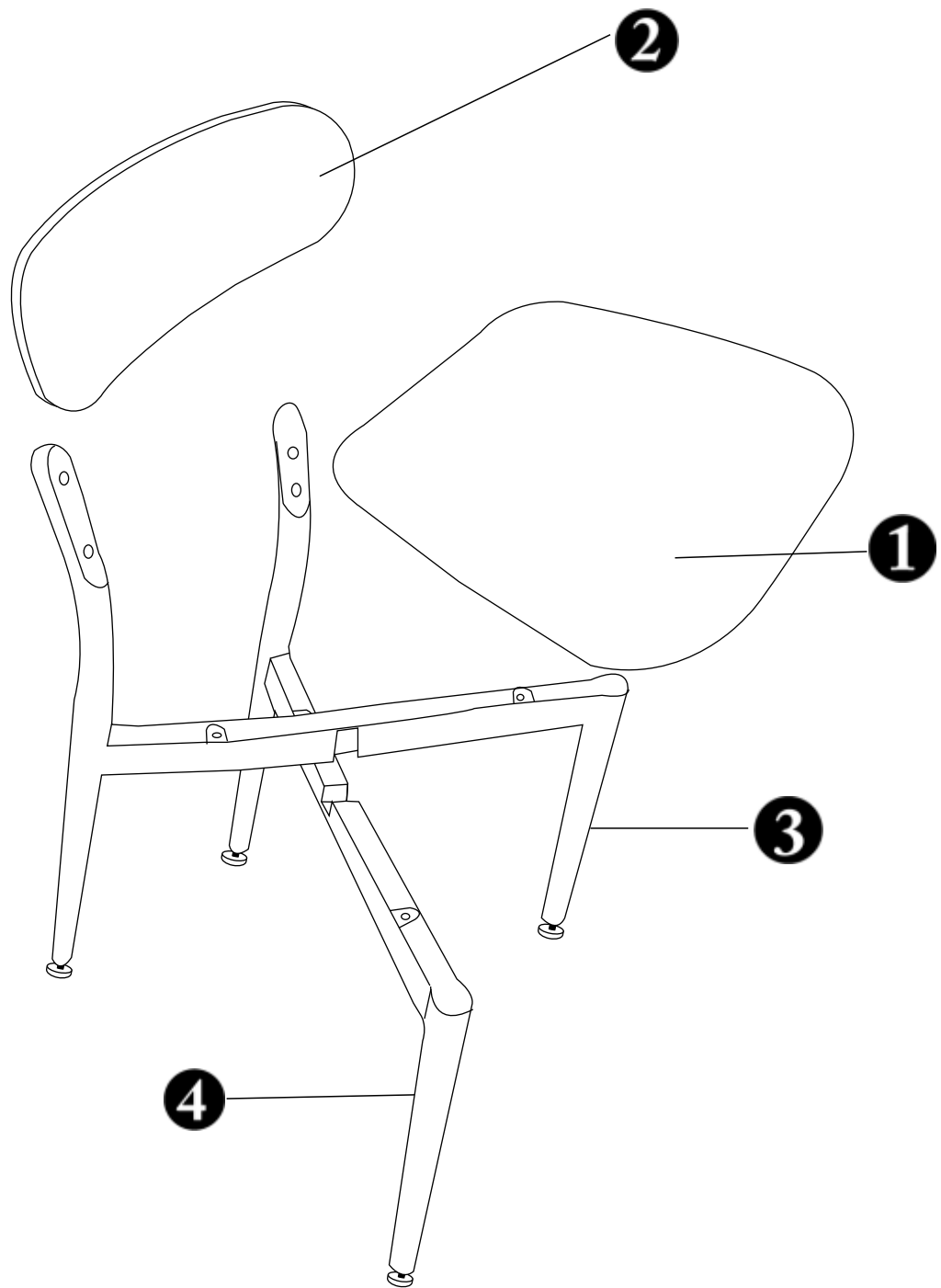

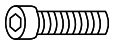





 10 MIN	
--	---



<b>A</b>  M6X40mm X5	<b>B</b>  5mm X1	<b>C</b>  M6/φ12mm X5	<b>D</b>  M6X16mm X4	<b>E</b>  M6 X9
<b>F</b>  M6/φ14mm X4				

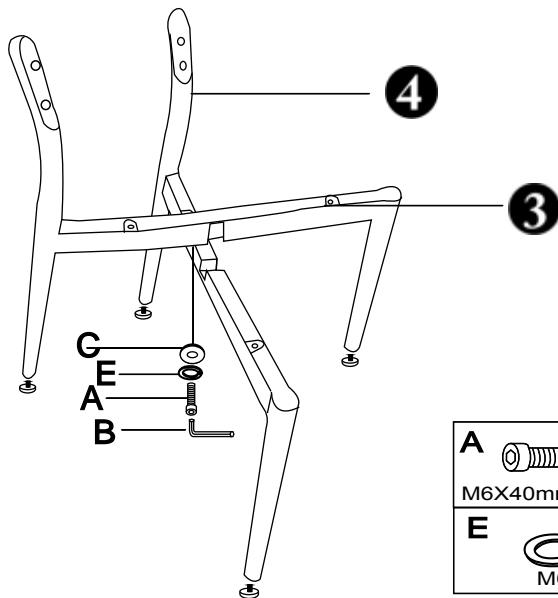



1

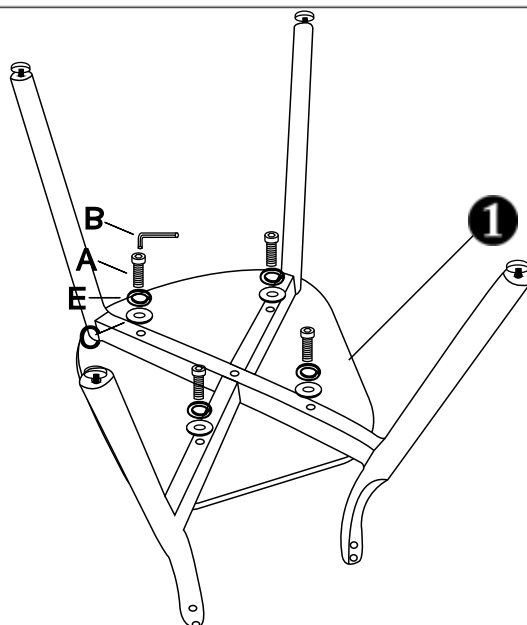

<b>A</b>  M6X40mm X1	<b>B</b>  5mm X1	<b>C</b>  M6/φ12mm X1
<b>E</b>  M6 X1		



2

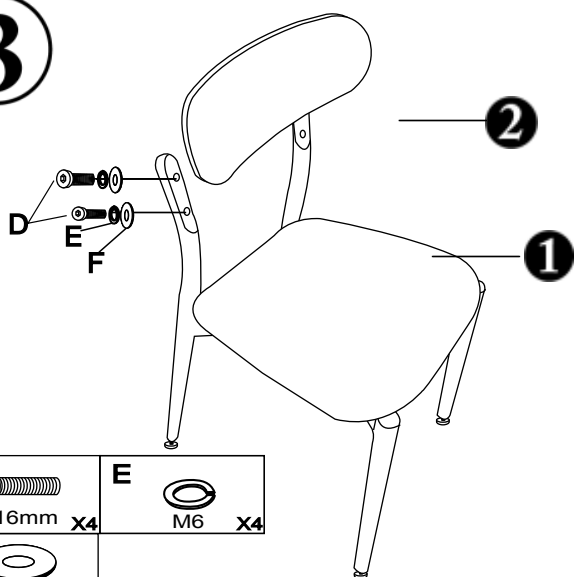

<b>A</b>  M6X40mm X4	<b>B</b>  5mm X1
<b>E</b>  M6 X4	<b>C</b>  M6/φ12mm X4

3



<b>D</b>  M6X16mm X4	<b>E</b>  M6 X4
<b>F</b>  M6/φ14mm X4	

4

