





 15 MIN		
--	---	---

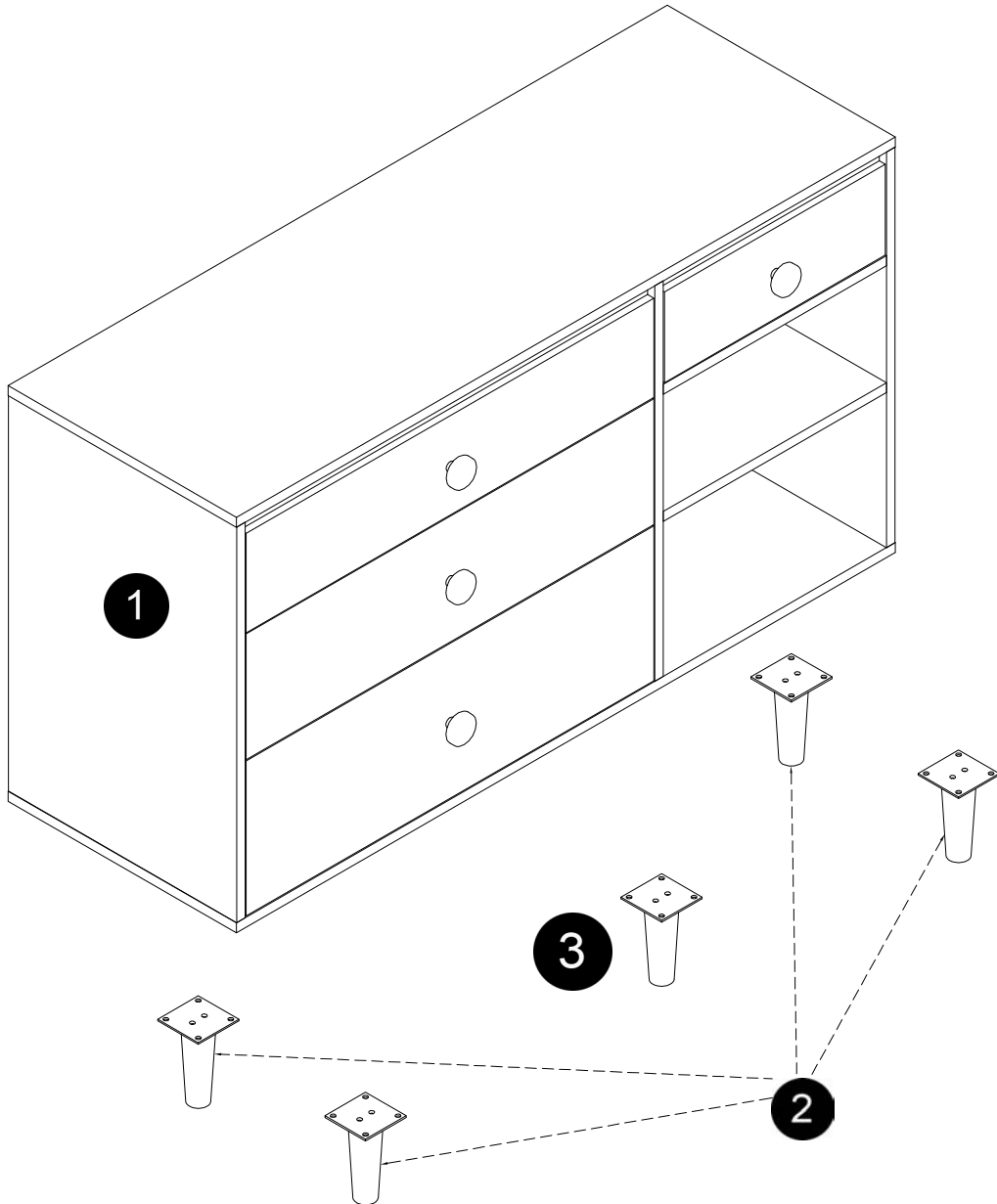

A $\varnothing 6 \times 15 \text{mm}$	B M 4
	
X20	X1

1

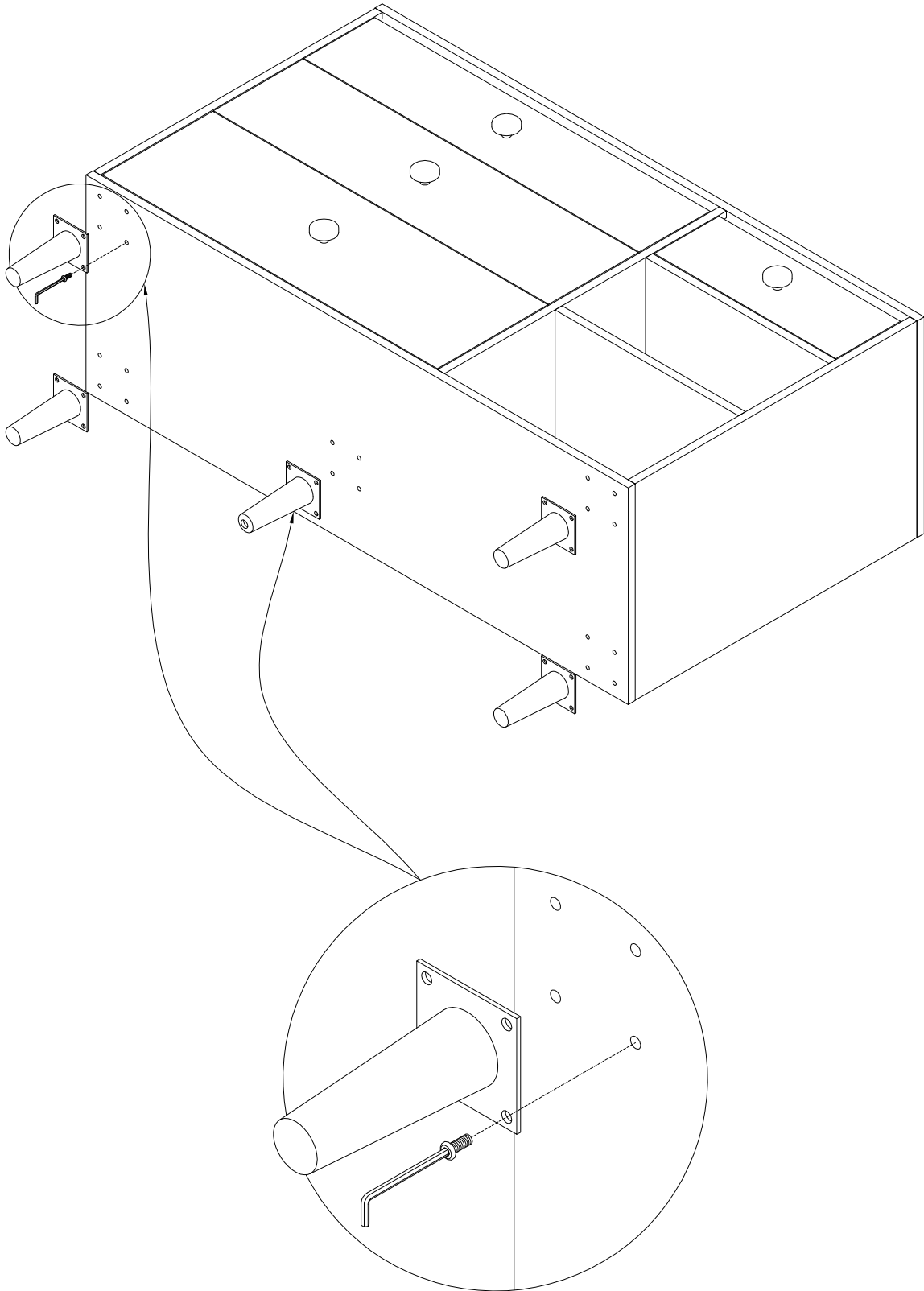

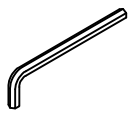
A Ø6*15mm	B M 4
	
X20	X1

2

