

 15 MIN		
---	---	---

①



②



③

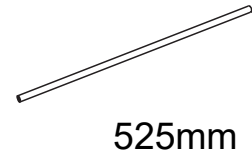

525mm



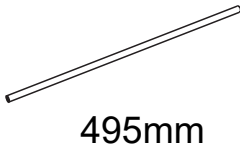

④

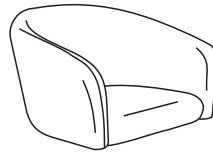

495mm

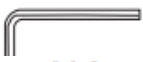

⑤



<p>A</p>  <p>M6x35 mm</p> <p>X6</p>	<p>B</p>  <p>M6x25 mm</p> <p>X4</p>	<p>C</p>  <p>M6</p> <p>X1</p>	<p>D</p>  <p>M5</p> <p>X1</p>
---	---	---	---

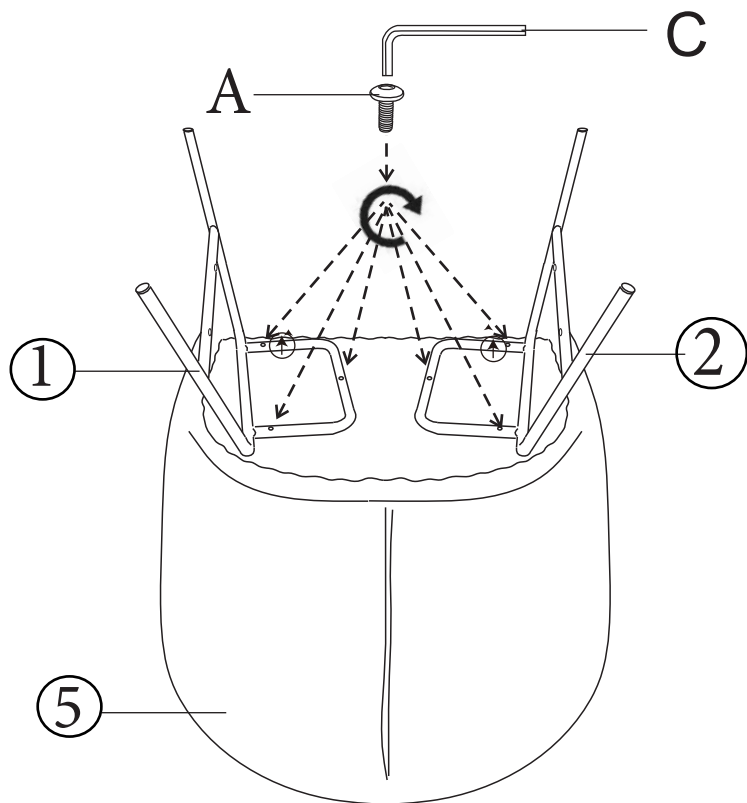

①

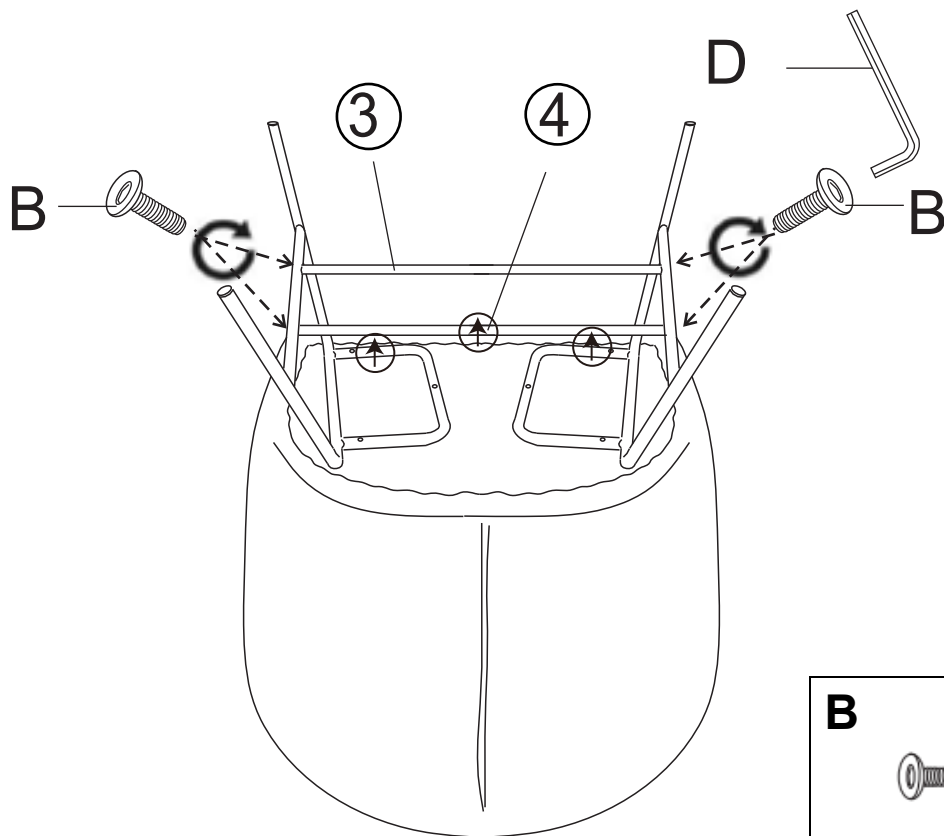

A  M6x35 mm X6	C  M 6 X1
---	--

②



B  M6x25 mm X4	D  M 5 X1
---	--

3

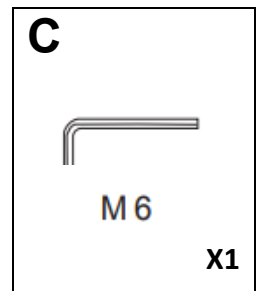
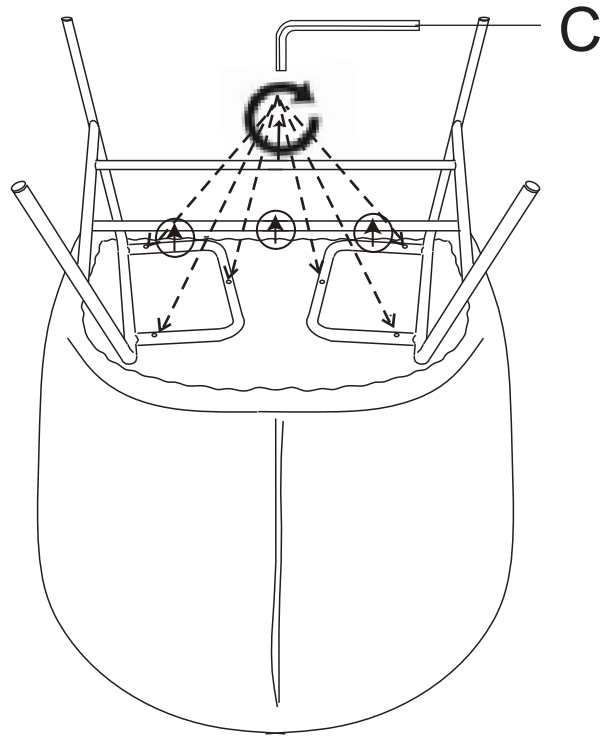

4

