

TROPICCOOL

181 875

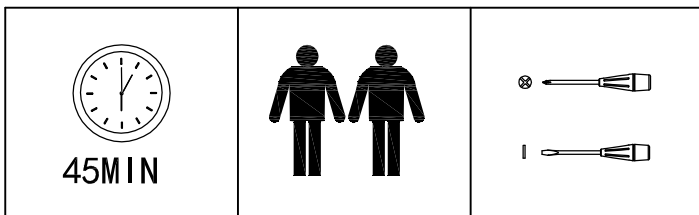

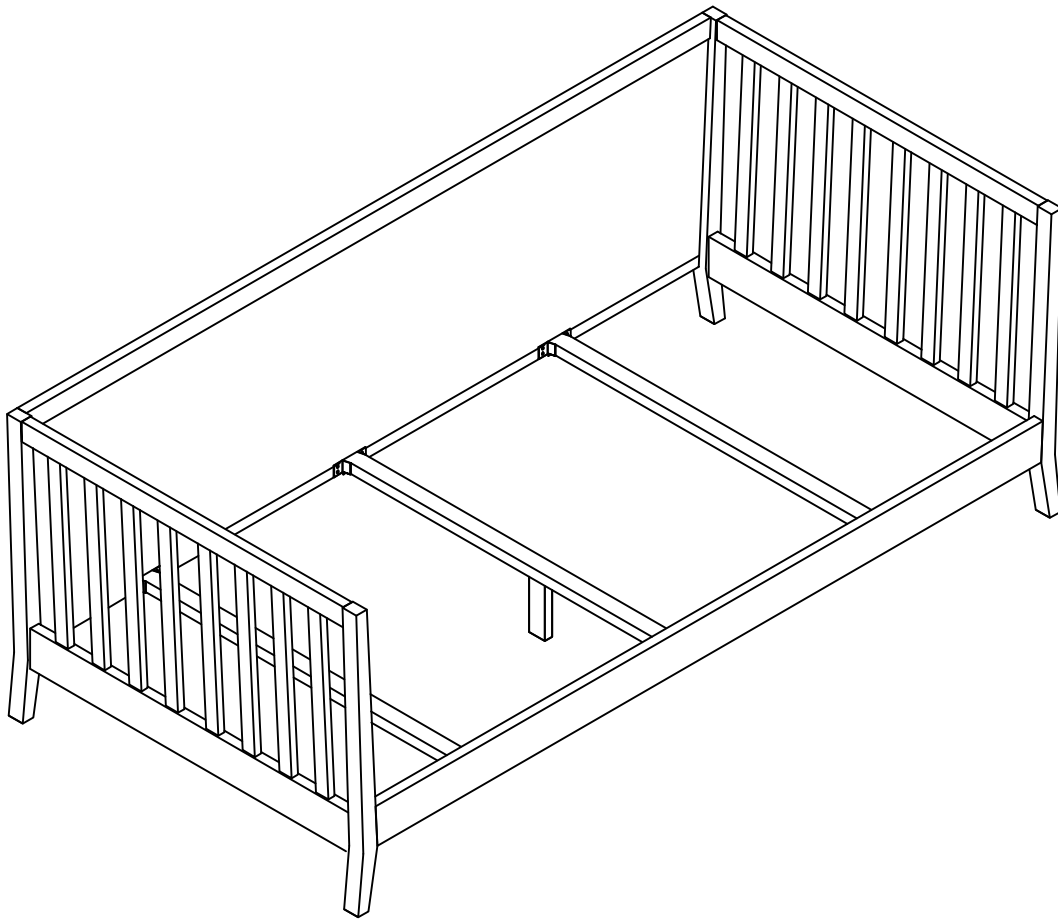

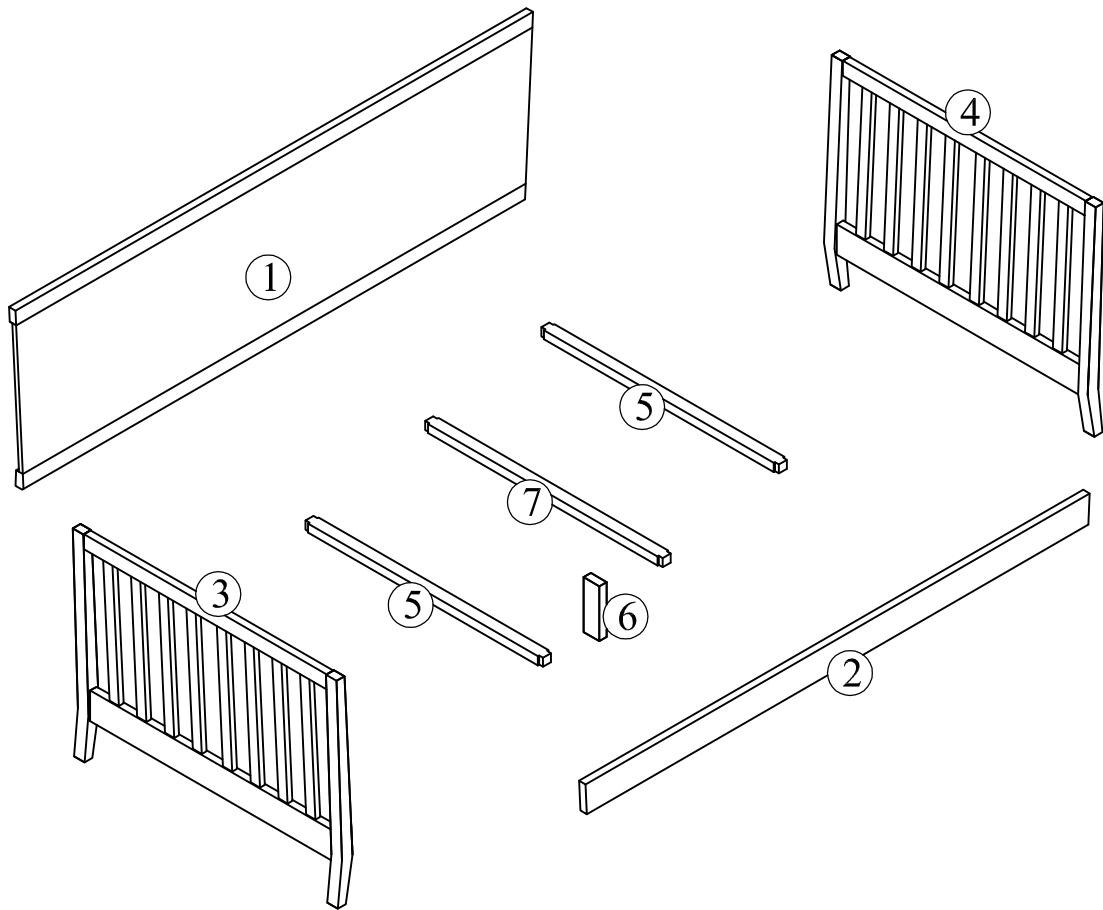
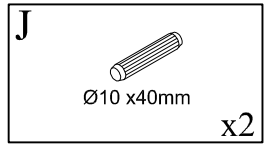
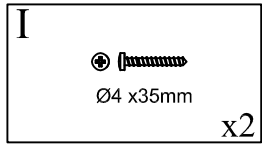
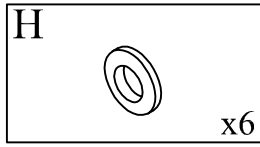
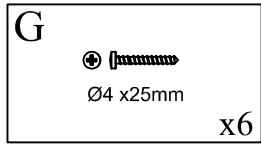
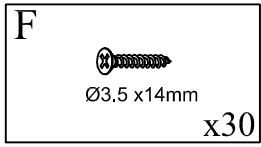
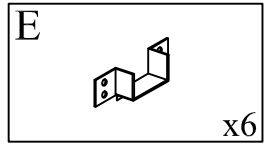
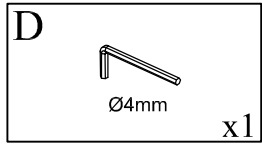
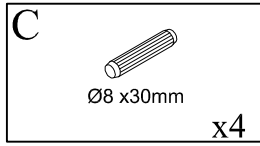
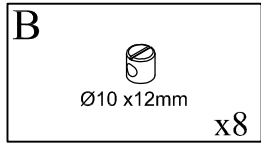
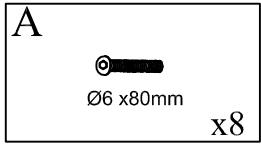
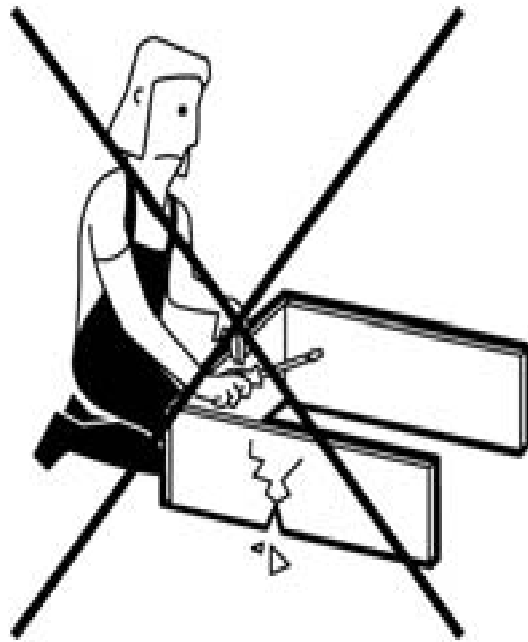



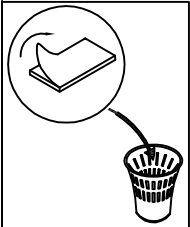
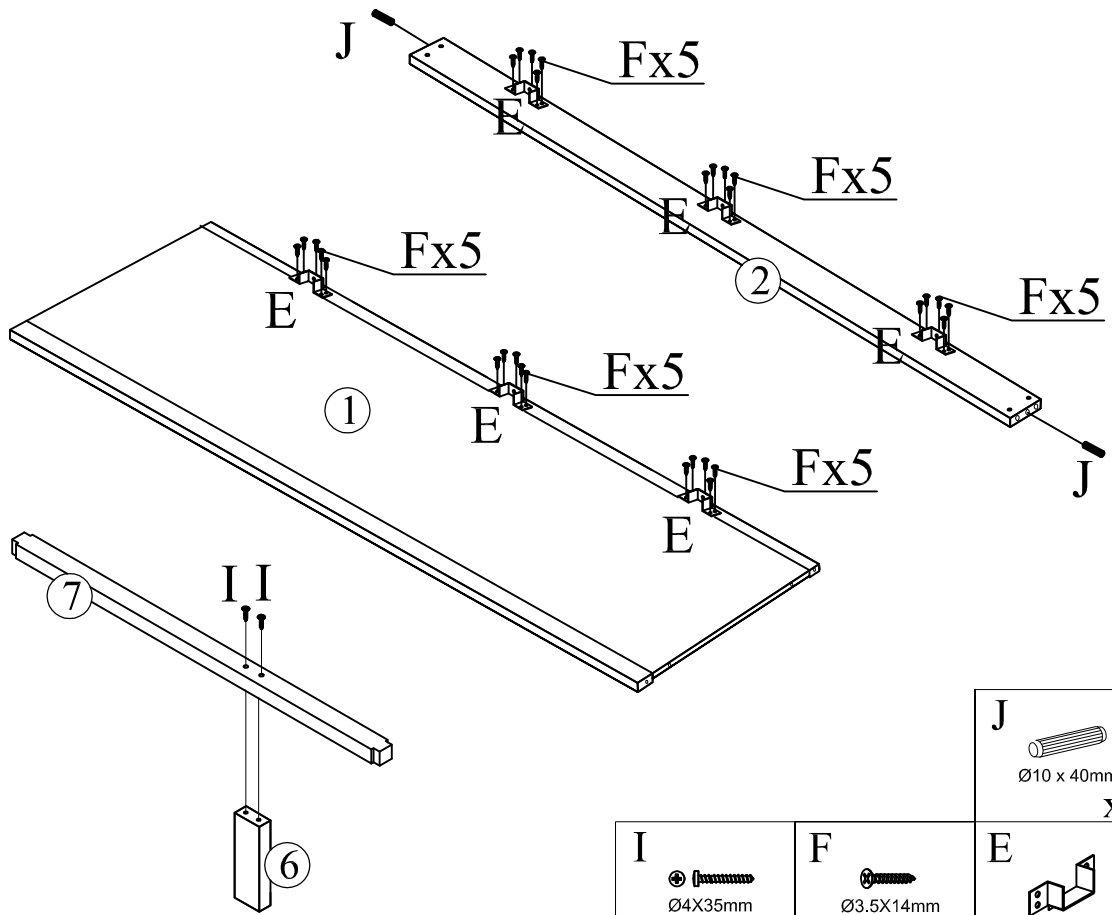

1



I

 Ø4X35mm
 x2

F

 Ø3.5X14mm
 x30

E

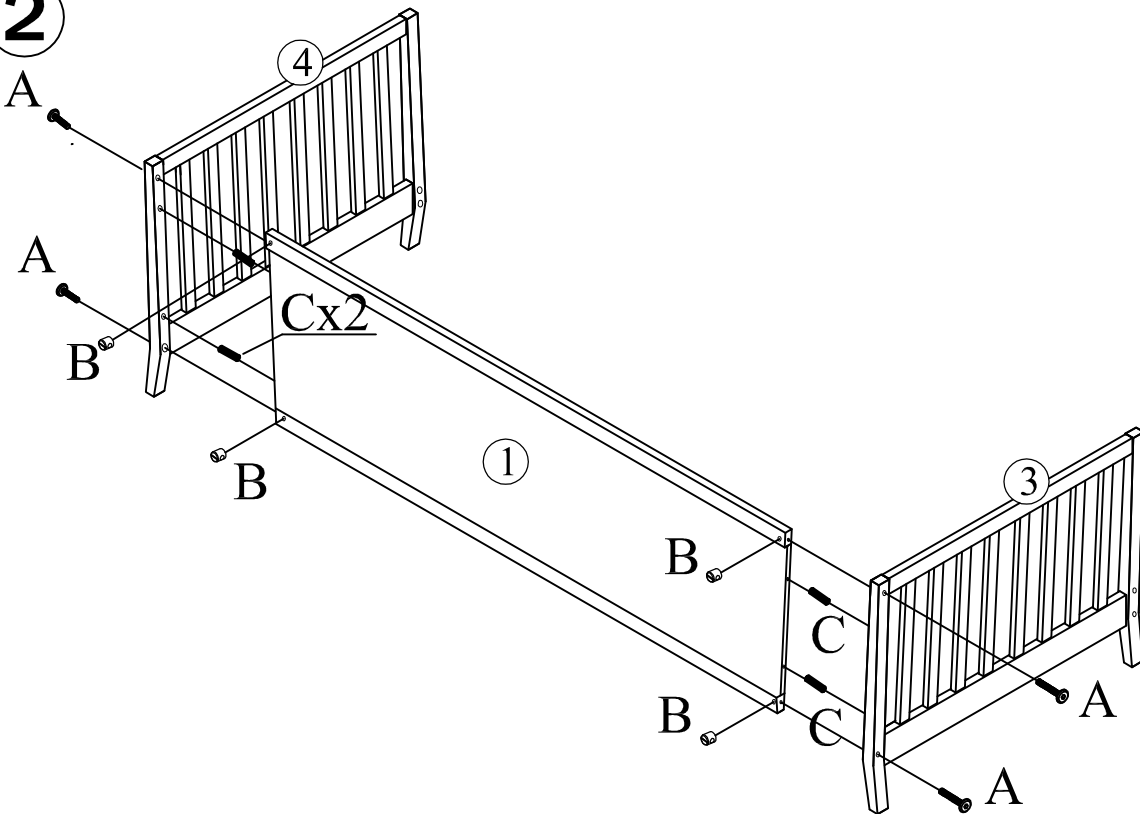
 x6

J

 Ø10 x 40mm
 x2

2



A

 Ø6X60mm
 x4



B

 Ø10X12mm
 x4

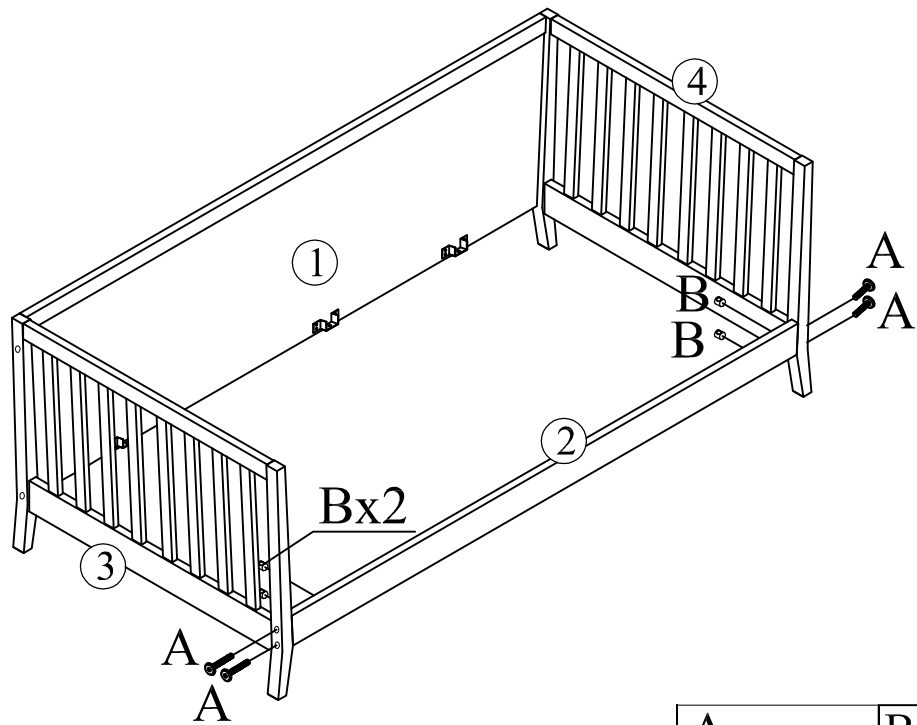
C

 Ø8X30mm
 x4

D

 x1



3

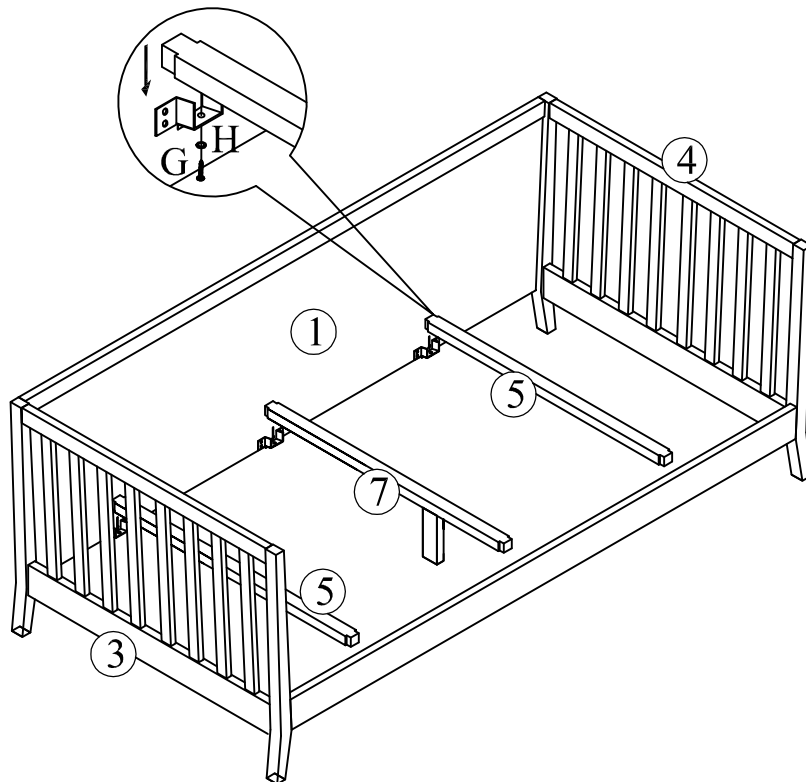

A  Ø6X60mm x4	B  Ø10X12mm x4
---	---

4



H  Ø6mm x6	G  Ø4X25mm x6
--	---