











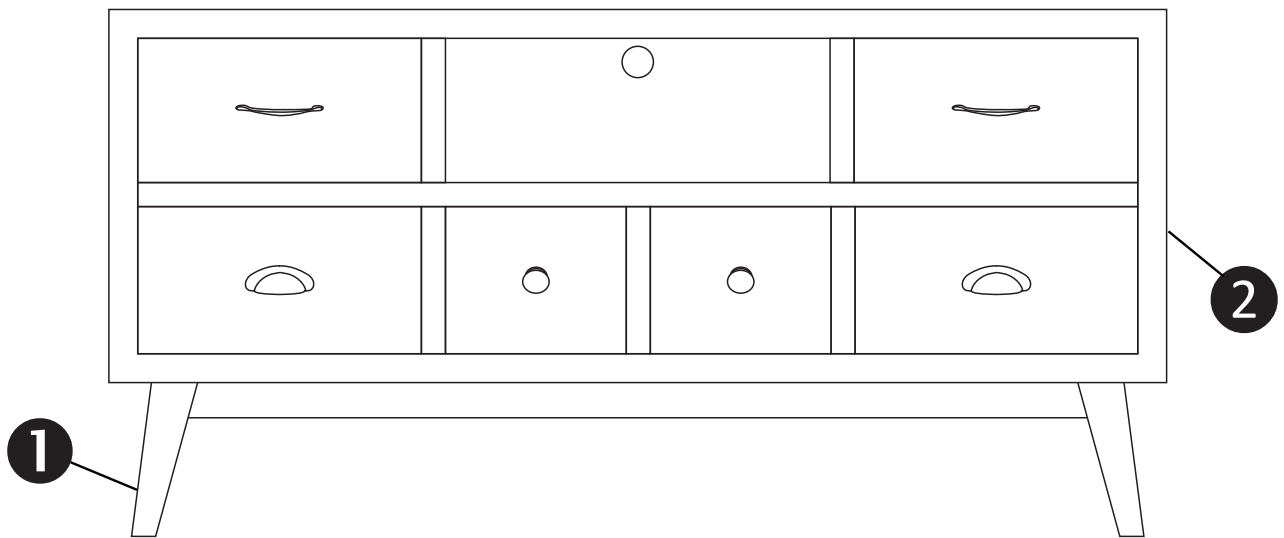
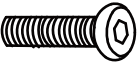

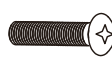

 15 MIN		
--	---	---

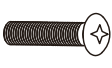

A  M6x45MM X8	B  \varnothing 16mm X8	C  \varnothing 16mm X8	D  M4x16MM X4	E  M3.5x12MM X4	F  \varnothing 10mm X6	G  M5x20MM X4	H  M4x18MM X2
I  X2	J  X2	K  X2	L  X1				

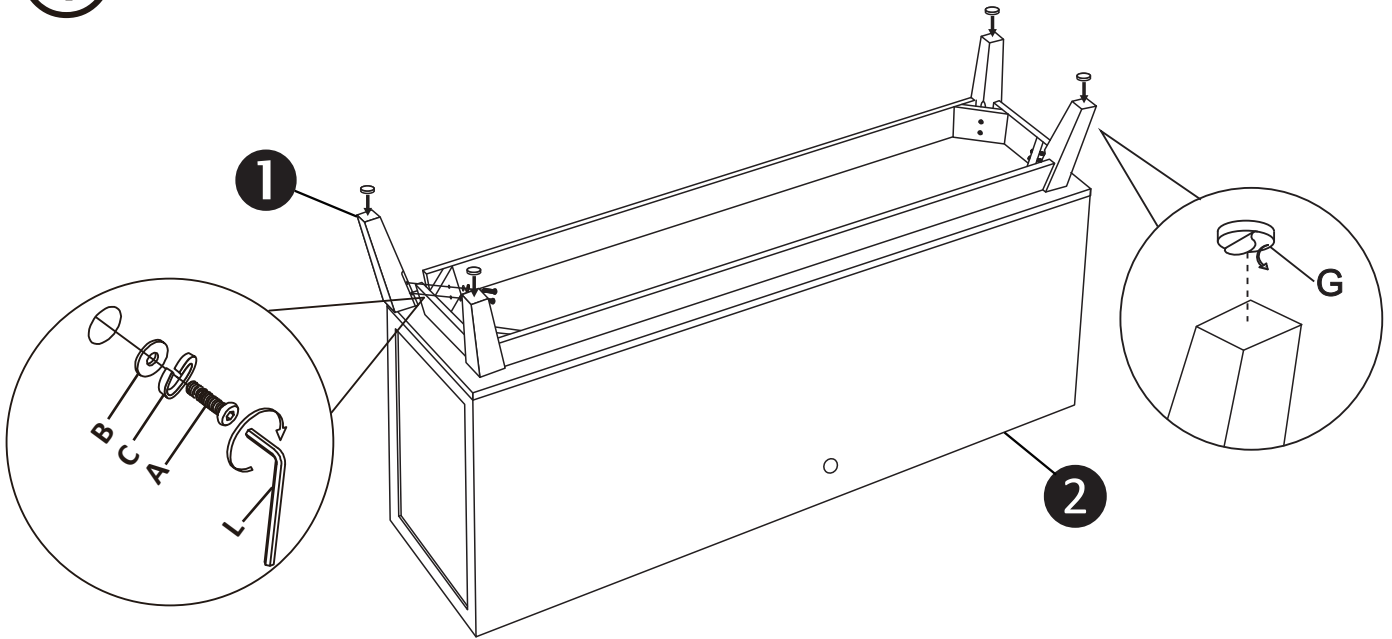
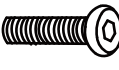





1

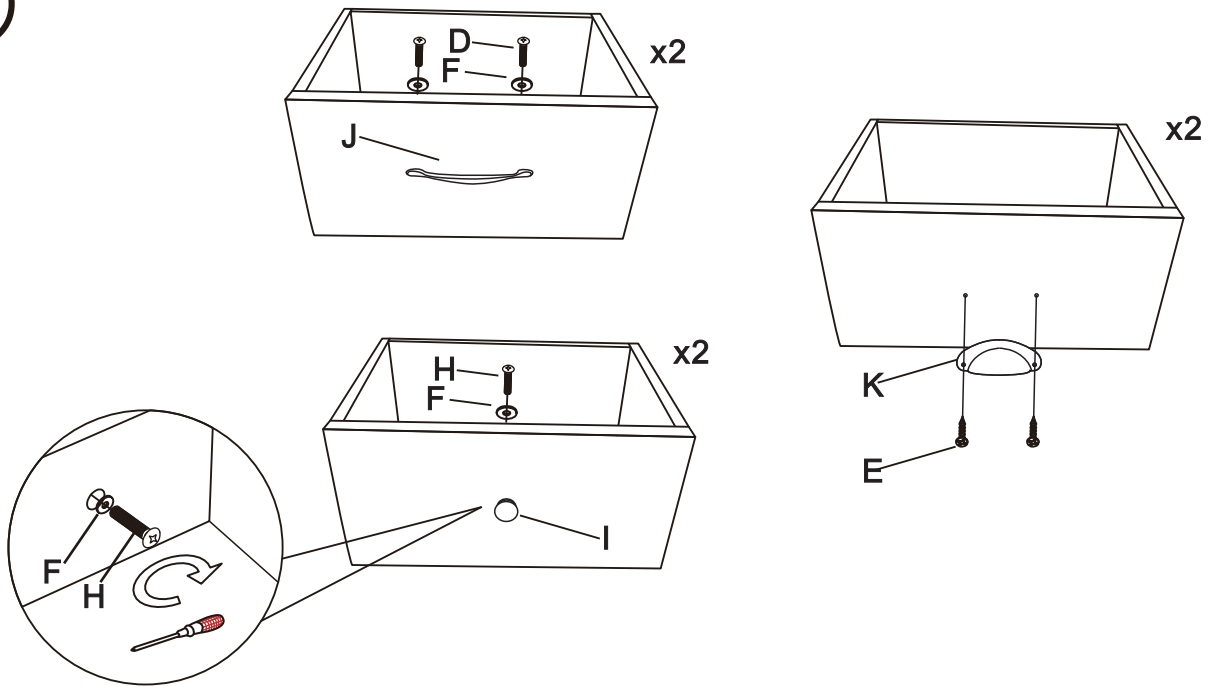

<p>A</p>  <p>M6x45MM X8</p>	<p>B</p>  <p>Ø16mm X8</p>	<p>C</p>  <p>Ø16mm X8</p>	<p>G</p>  <p>M5x20MM X4</p>	<p>L</p>  <p>X1</p>
---	---	---	---	---

2



<p>F</p>  <p>Ø10mm X6</p>	<p>E</p>  <p>M3.5x12MM X4</p>	<p>I</p>  <p>X2</p>	<p>J</p>  <p>X2</p>	<p>K</p>  <p>X2</p>	<p>H</p>  <p>M4x18MM X2</p>	<p>D</p>  <p>M4x16MM X4</p>
---	---	---	--	---	---	---

③

