

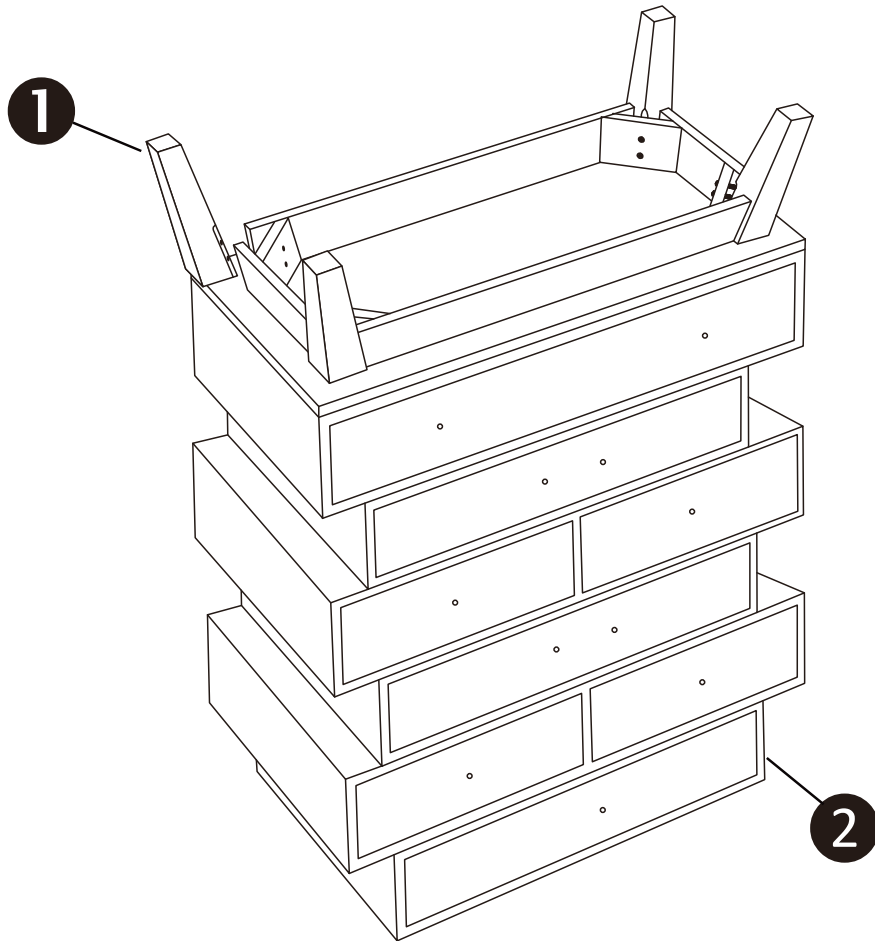

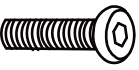















 15 MIN		
--	---	---

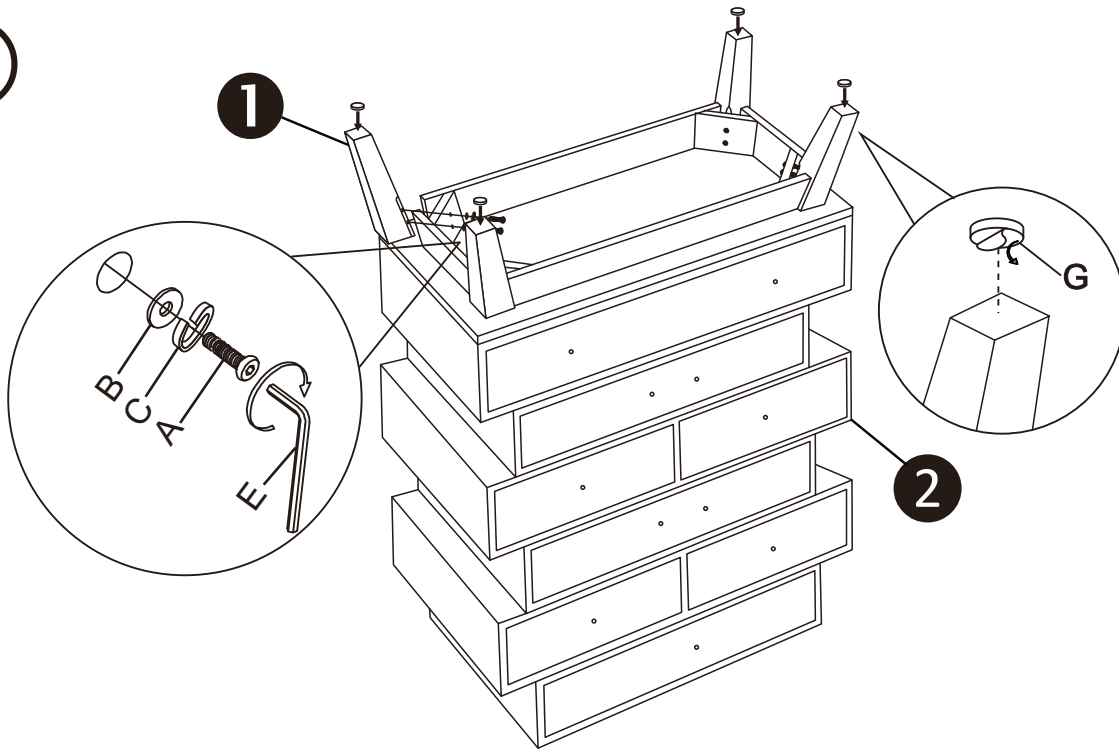

A  M6x45MM X8	B  M6 X8	C  M6 X8	D  M4x14MM X4	E  X1	F  M4 X11	G  M5x20MM X4	H  M4x16MM X7
I  X3	J  X2	K  X4					





1

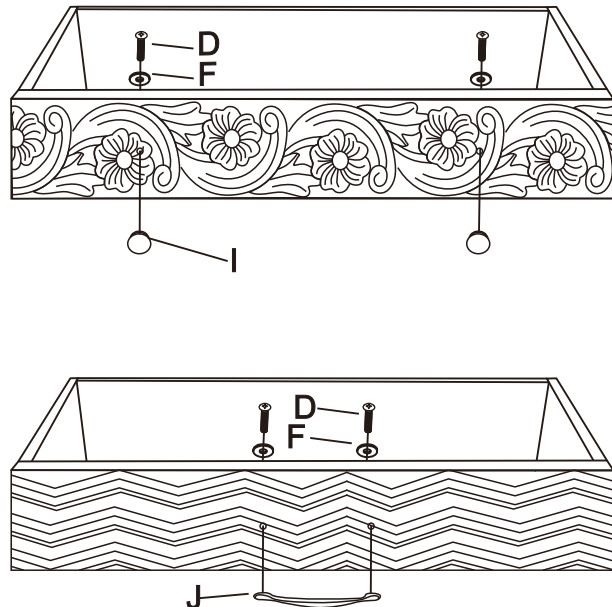

<p>A</p>  <p>M6x45MM X8</p>	<p>B</p>  <p>M6 X8</p>	<p>C</p>  <p>M6 X8</p>	<p>E</p>  <p>X1</p>	<p>G</p>  <p>M5x20MM X4</p>
---	---	--	---	---





2

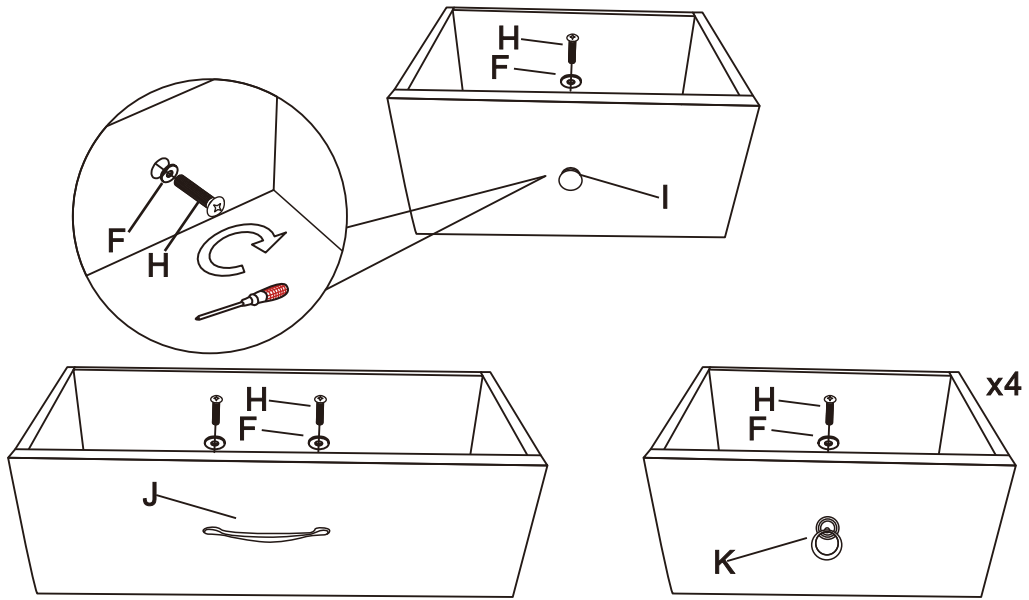

<p>D</p>  <p>M4x14MM X4</p>	<p>F</p>  <p>M4 X4</p>	<p>I</p>  <p>X2</p>	<p>J</p>  <p>X1</p>
--	--	---	---

3



F  M4 X7	I  X1	J  X1	K  X4	H  M4x16MM X7
---	---	---	---	--

4

