

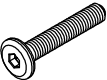







| | | | | |
|---|---|---|---|---|
| A Ø8*40mm  X8 | B key 4  X1 | C M8*19mm  X8 | D M8*14mm  X8 | E Ø6*15mm  X8 |
|---|---|---|---|---|

①

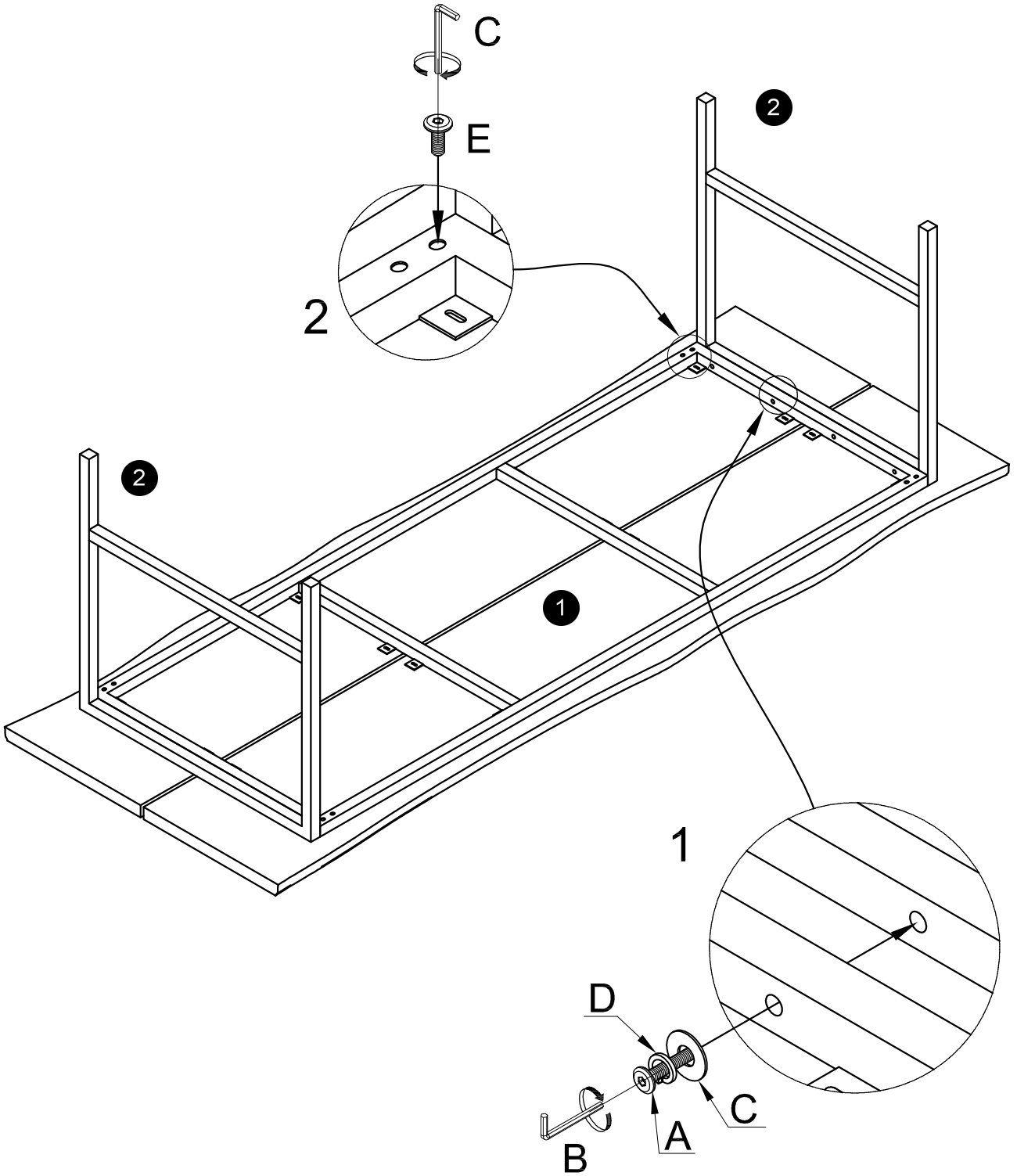
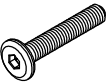

| A | B | C | D | E |
|--|--|--|--|--|
|  Ø8*40mm X8 |  key 4 X1 |  M8*19mm X8 |  M8*14mm X8 |  Ø6*15mm X8 |