

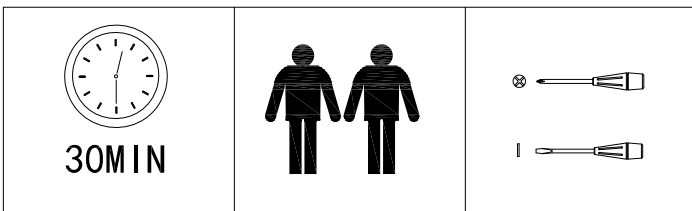

PENELOPE

187522

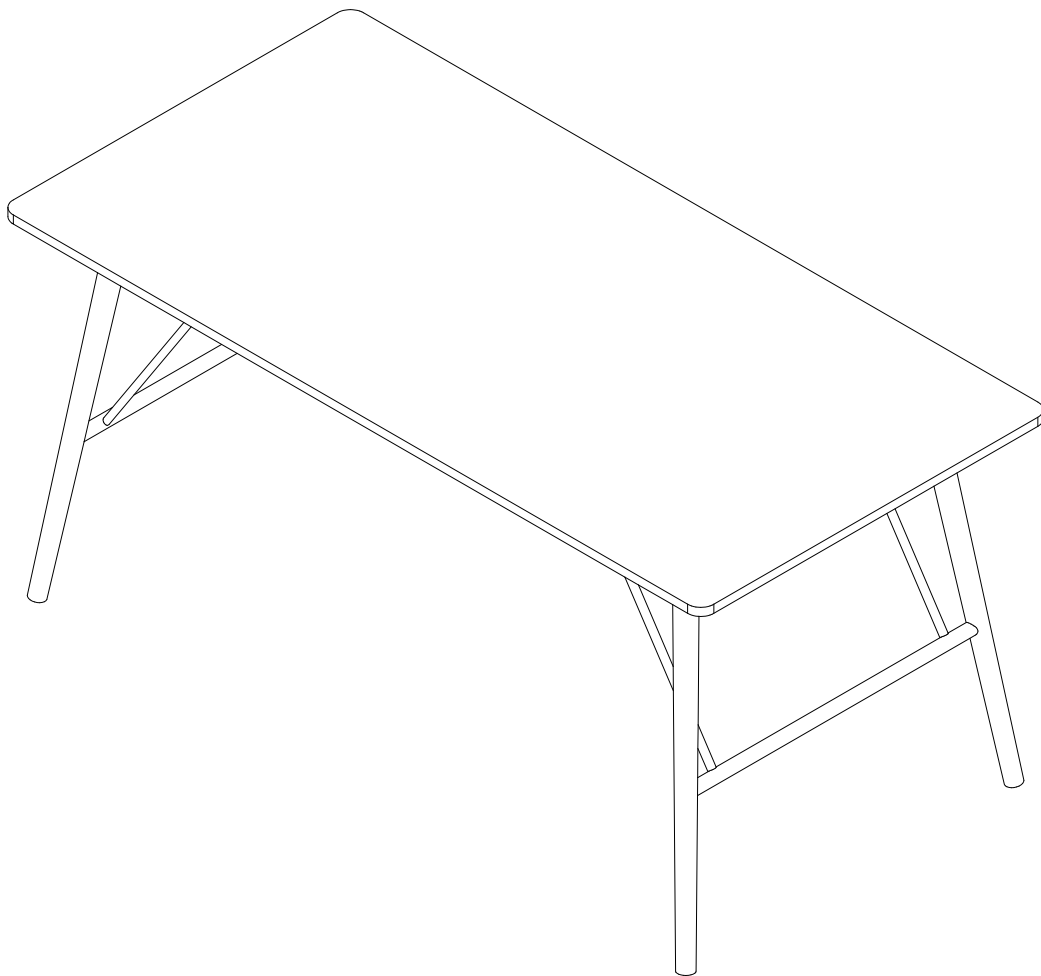

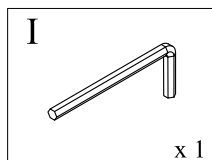
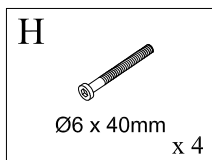
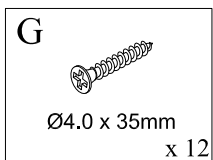
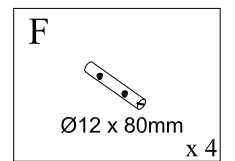
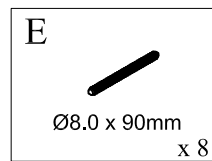
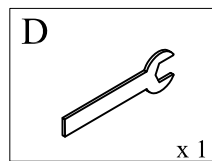
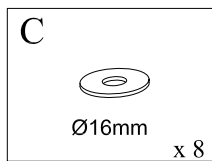
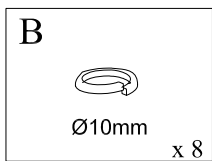
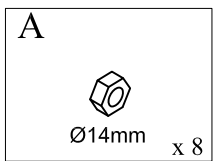
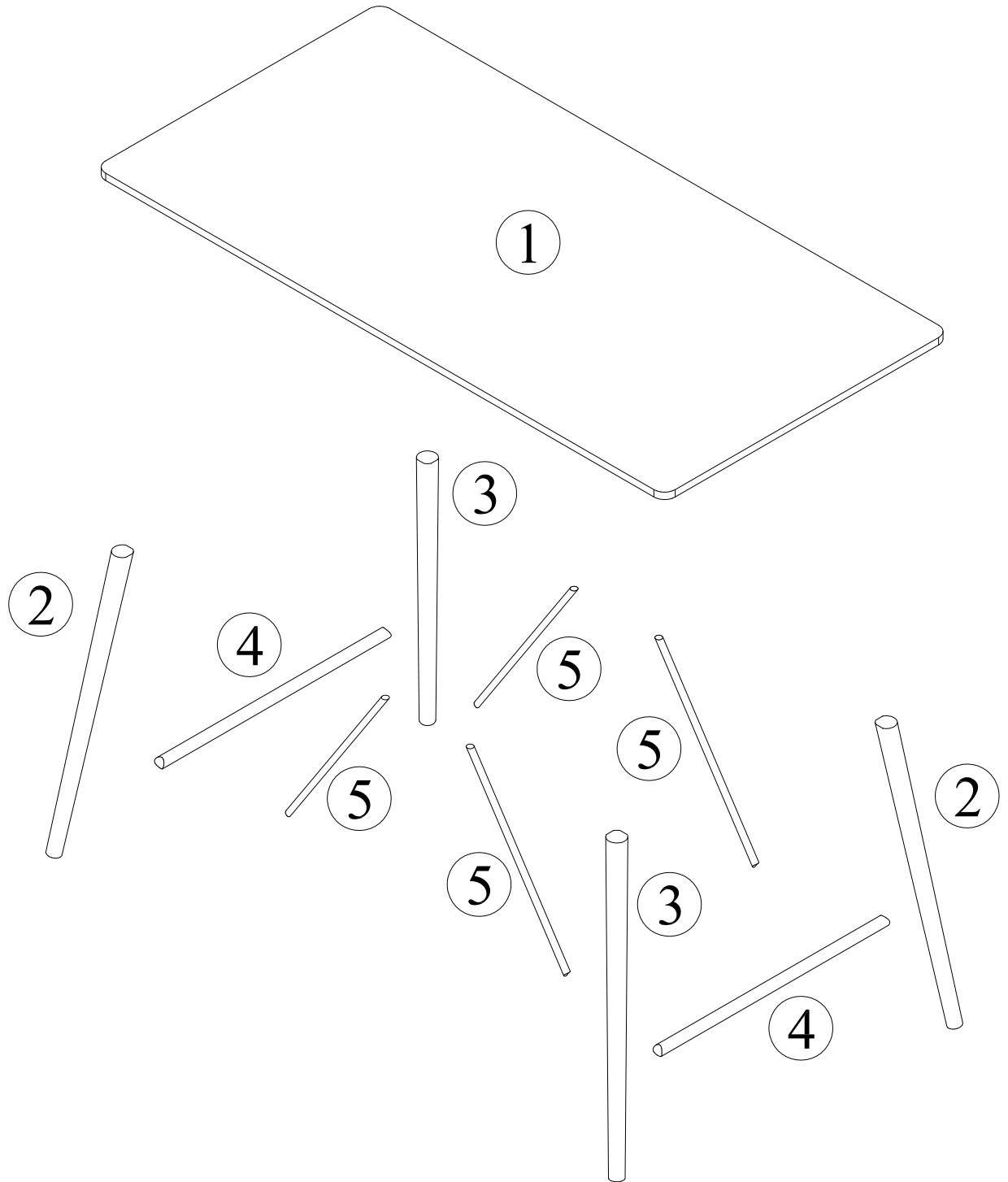

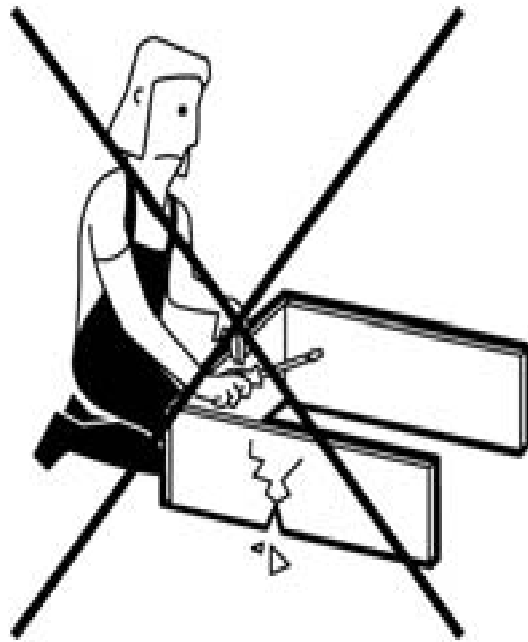

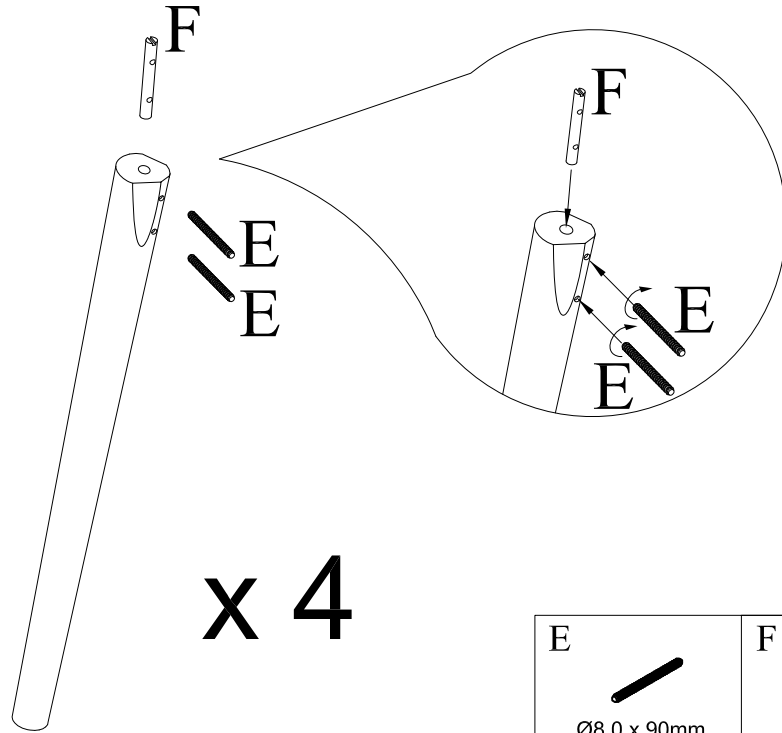

1





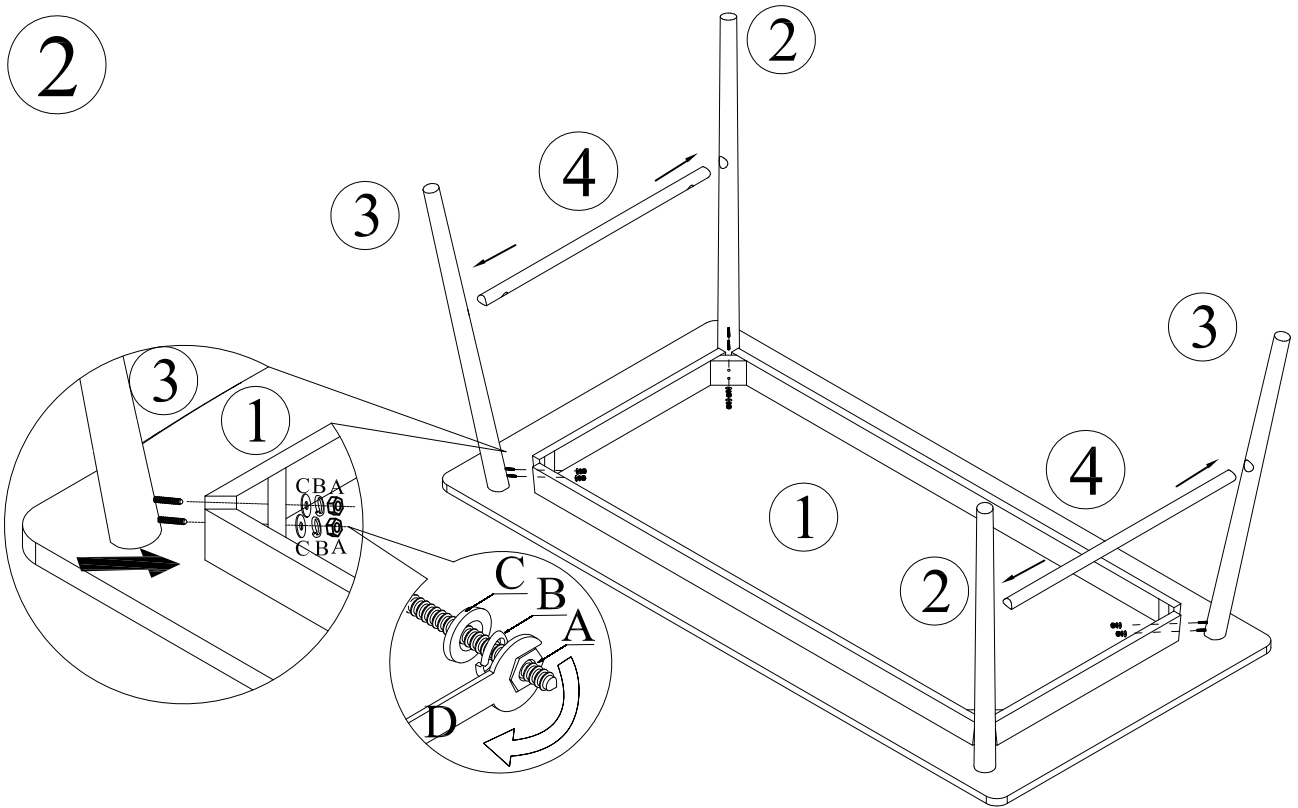

x 4

<p>E</p>  <p>Ø8.0 x 90mm x 8</p>	<p>F</p>  <p>Ø12 x 80mm x 4</p>
-------------------------------------------------------------------------------------------------------------------------	------------------------------------------------------------------------------------------------------------------------

2



<p>A</p>  <p>Ø14mm x 8</p>	<p>B</p>  <p>Ø10mm x 8</p>	<p>C</p>  <p>Ø16mm x 8</p>	<p>D</p>  <p>x 1</p>
-------------------------------------------------------------------------------------------------------------------	-------------------------------------------------------------------------------------------------------------------	---------------------------------------------------------------------------------------------------------------------	-----------------------------------------------------------------------------------------------------------

3

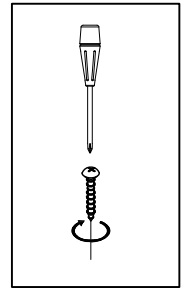
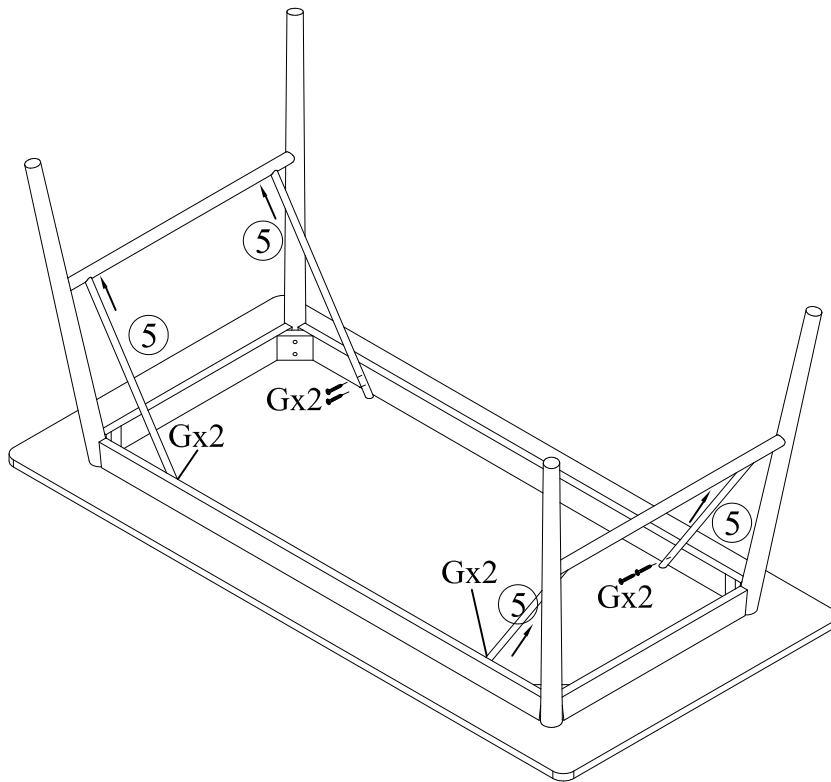

G

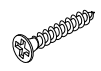

Ø4.0 x 35mm
x 8

4

