











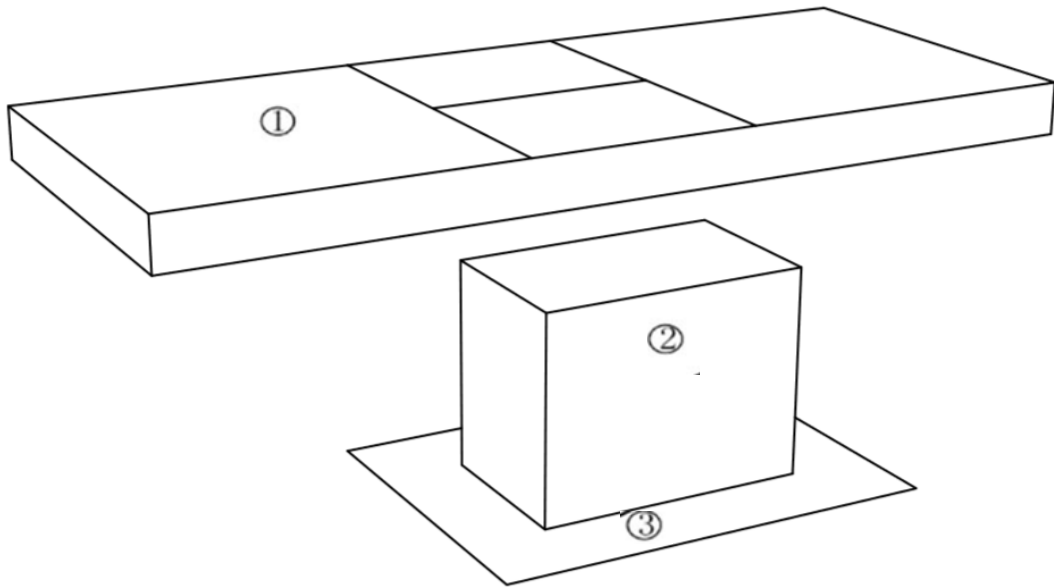

|  |        |   |   |
|--|--------|---|---|
|  | 15 min |  |  |
|--|--------|---|---|

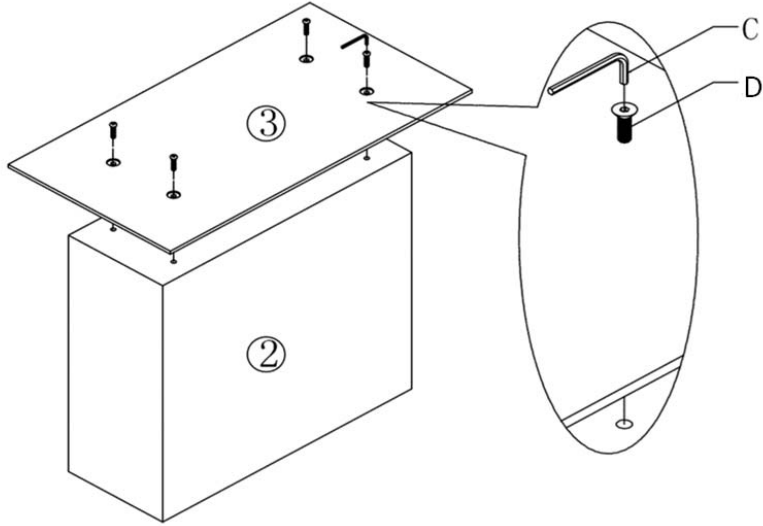

| ①  | ②   | ③   | A  | B   | C   | D   | E   |
|--|---|---|--|---|---|---|---|
|  |  |  | <br>M8x30MM |  |  | <br>M8x30MM |  |
| Table top<br>1pc   | Pedestal Column<br>1pc  | Base<br>1pc   | Bolt<br>4pcs   | Flat Washer<br>4pcs   | Allen Wrench<br>1pc   | Bolt<br>4pcs  | Flat Spring<br>4pcs   |

STEP 1



| C   | D   |
|---|---|
|  |  |
| Allen Wrench  | M8x30MM Bolt  |
| 1pc   | 4pcs  |

STEP 2

