

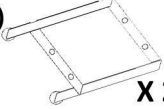

 30 MIN	
①  X 2	②  X 1
③  X 1	A  X 4
B  X 8	C  X 1

1

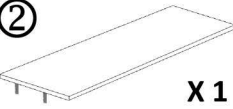
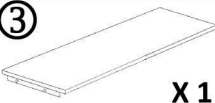

2

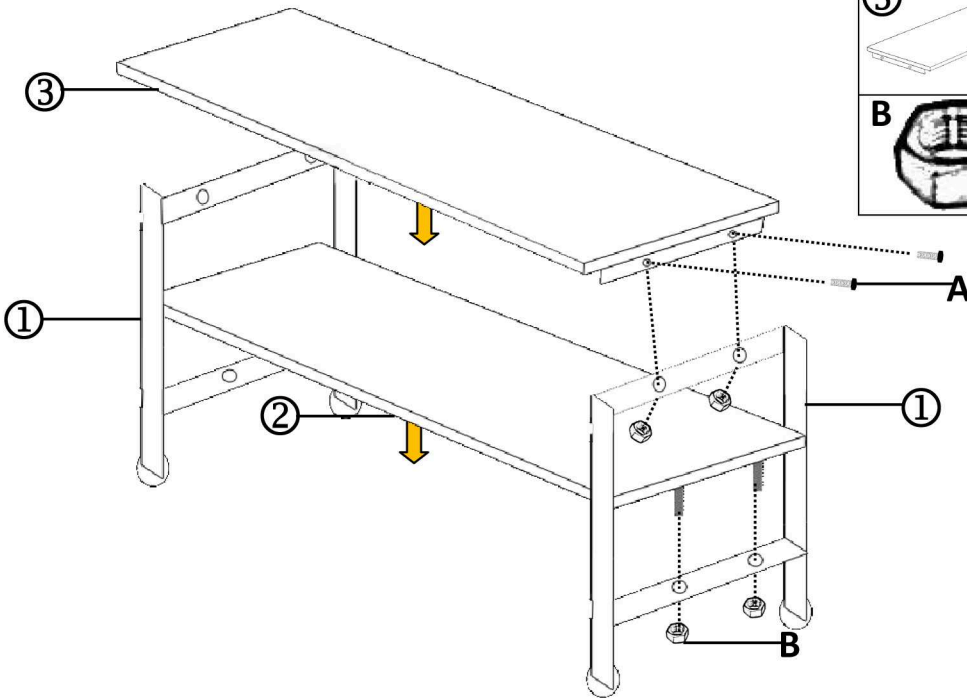