

MAISONS
DU MONDE

MANISA

198448

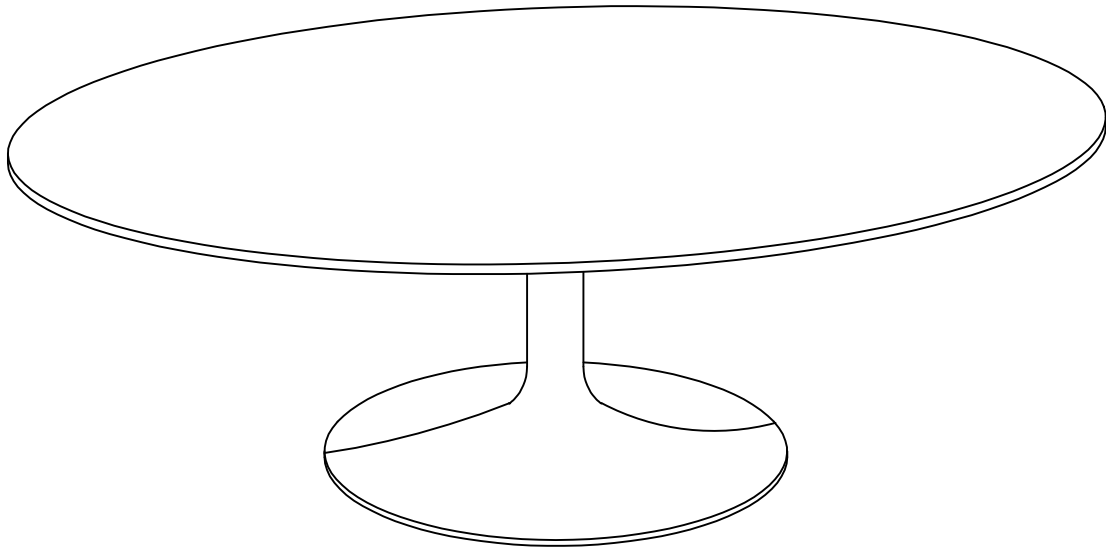

 20 MIN

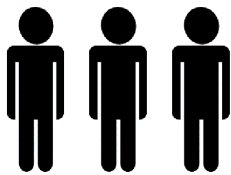

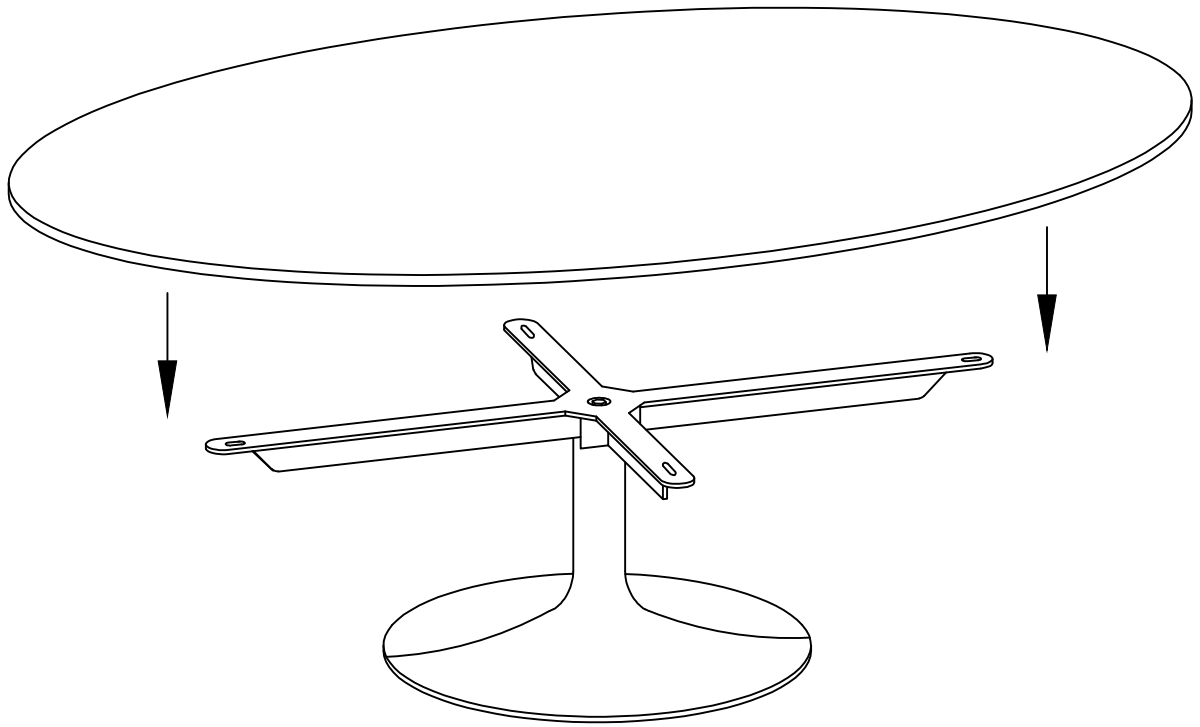
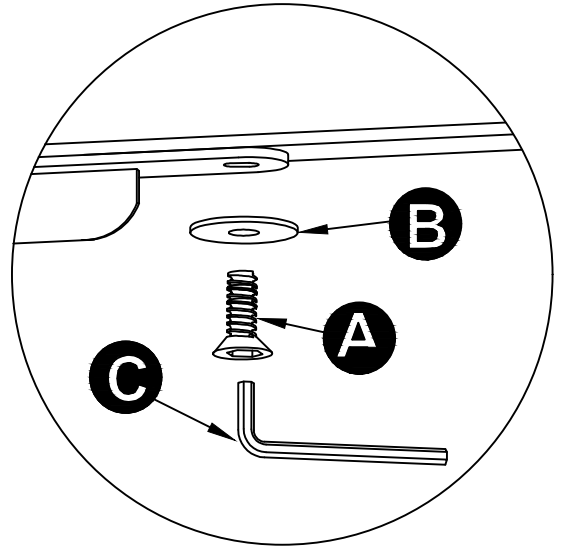

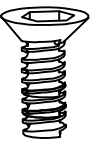
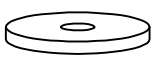
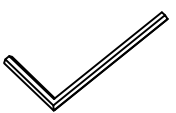
 A Ø09X20MM X4	 B 35mm X4	 C 8mm X1
--	--	---

