

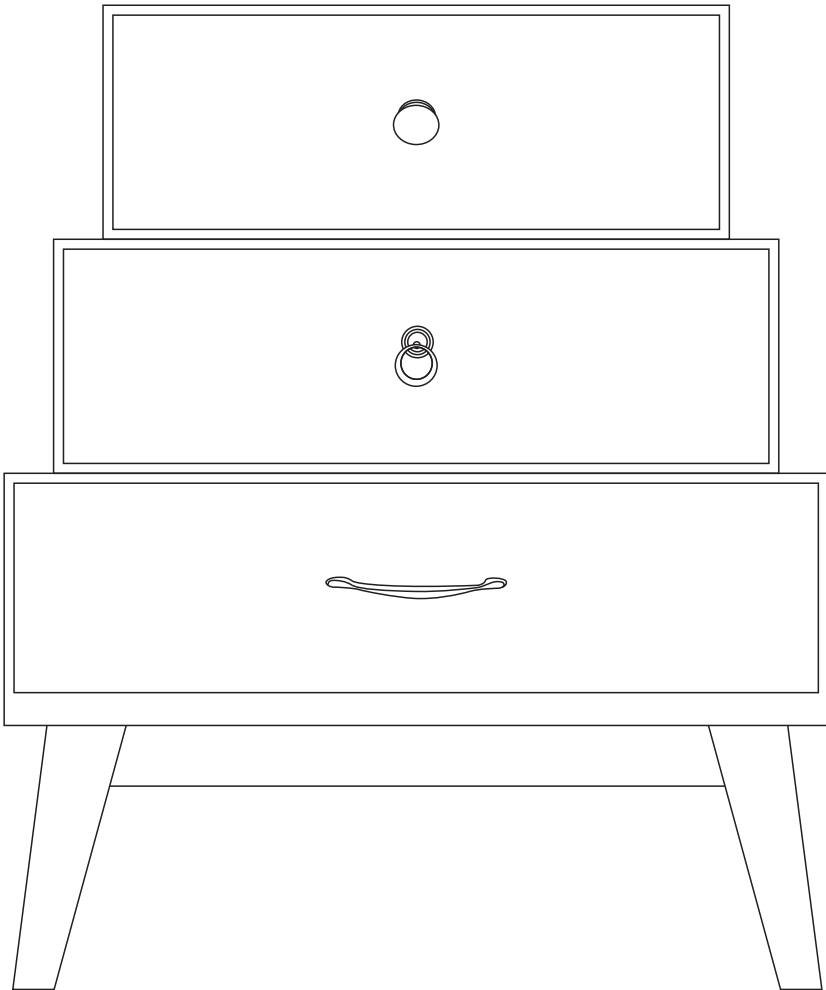











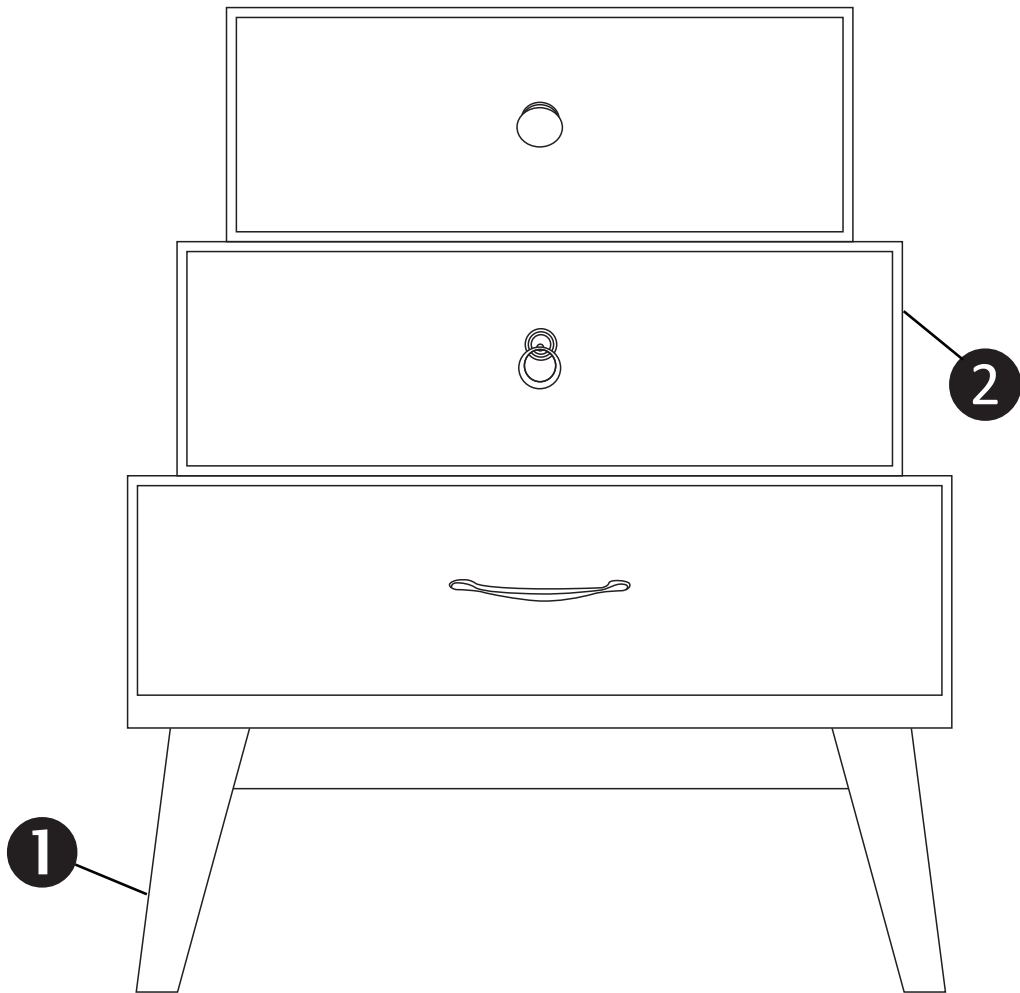



RUMBA

187498









 15 MIN		
--	---	---

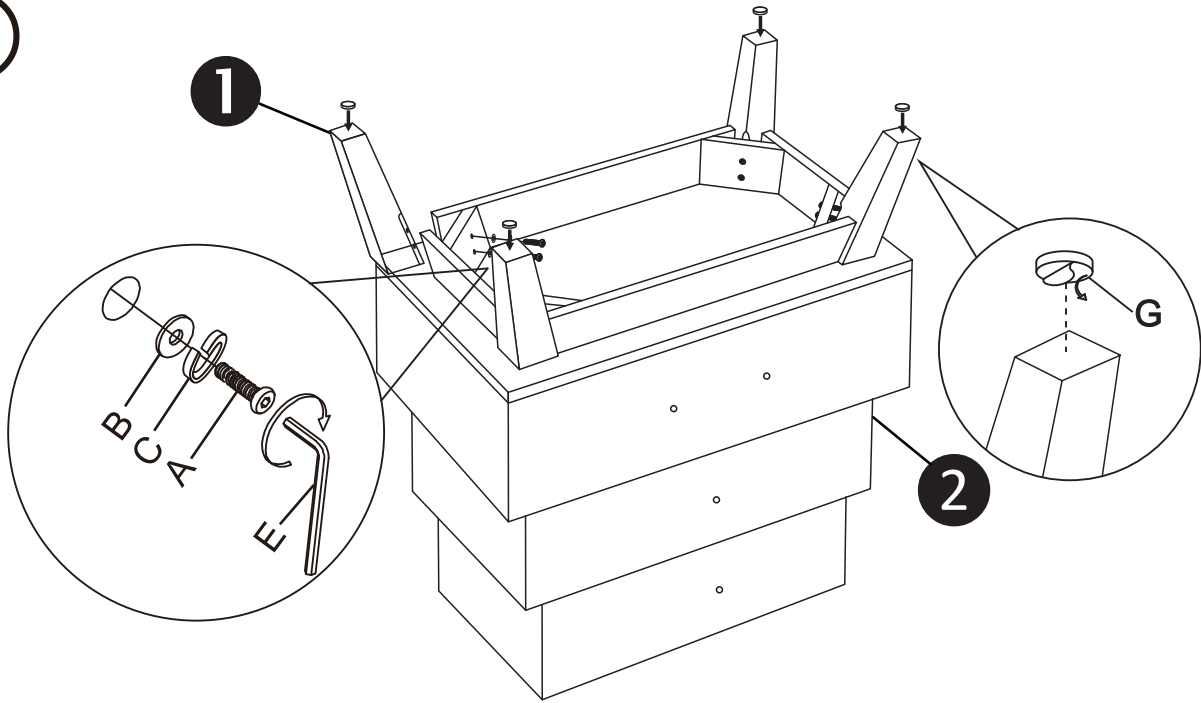

A  M6x45MM X8	B  Ø 16mm X8	C  Ø 16mm X8	D  M4x16MM X3	E  X1	F  Ø 10mm X4	G  M5x20MM X4	H  M4x18MM X1		
I  X1	J  X1	K  X1							







1

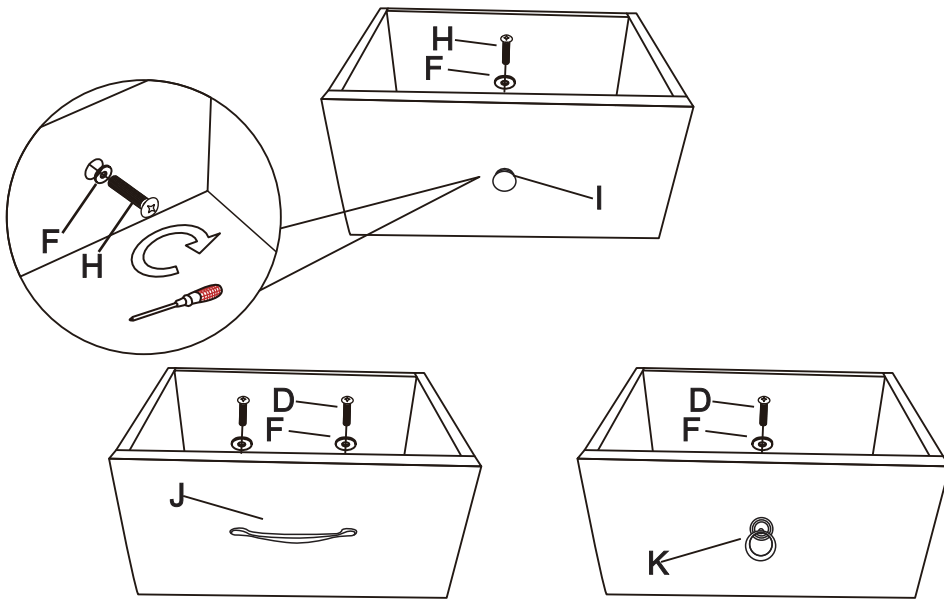

<p>A</p>  <p>M6x45MM X8</p>	<p>B</p>  <p>∅16mm X8</p>	<p>C</p>  <p>∅16mm X8</p>	<p>E</p>  <p>X1</p>	<p>G</p>  <p>M5x20MM X4</p>
---	--	---	---	---

2



<p>F</p>  <p>∅10mm X4</p>	<p>D</p>  <p>M4x16MM X3</p>	<p>I</p>  <p>X1</p>	<p>J</p>  <p>X1</p>	<p>K</p>  <p>X1</p>	<p>H</p>  <p>M4x18MM X1</p>
---	---	---	---	---	---

③

