

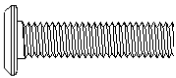





X3

<p><b>A</b></p>  <p>M6x60mm</p> <p>X6</p>	<p><b>B</b></p>  <p>M6</p> <p>X6</p>	<p><b>C</b></p>  <p>M6</p> <p>X6</p>	<p><b>D</b></p>  <p>4x64x25mm</p> <p>X1</p>
--	---	---	---

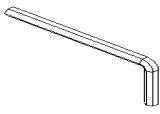
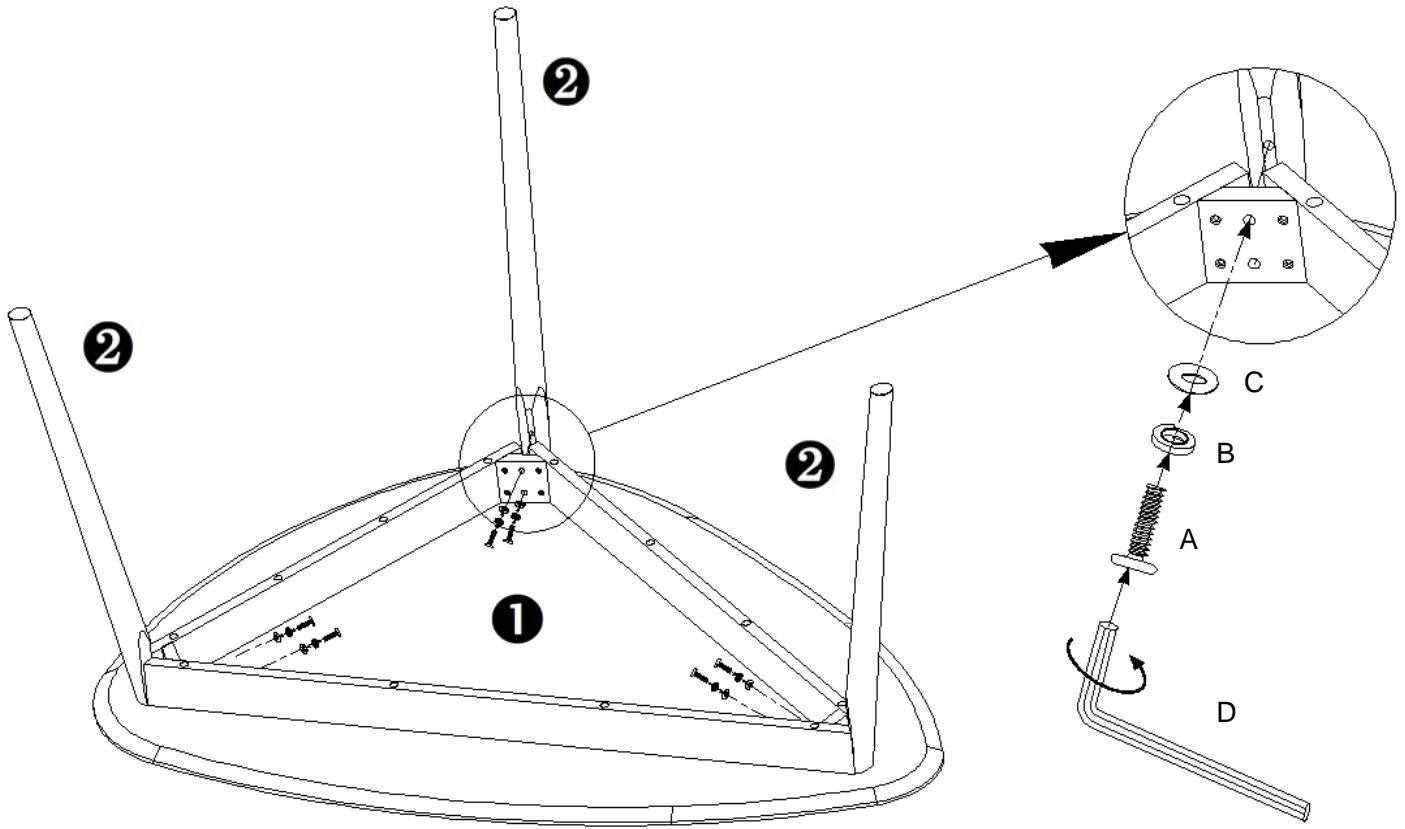
1



<b>A</b>  M6x60mm X6	<b>B</b>  M6 X6	<b>C</b>  M6 X6	<b>D</b>  4x64x25mm X1
--	---	---	---