

1

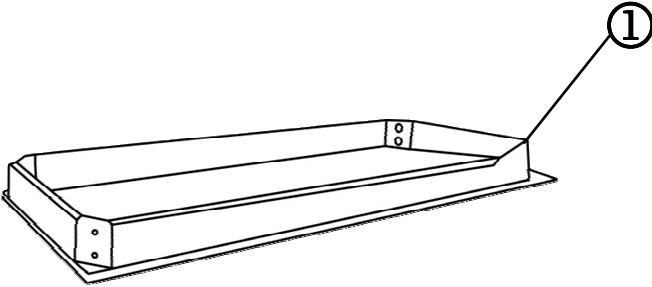

15 MIN	
① X 1	② X 4
A X 8	B X 8
	C X 1

2

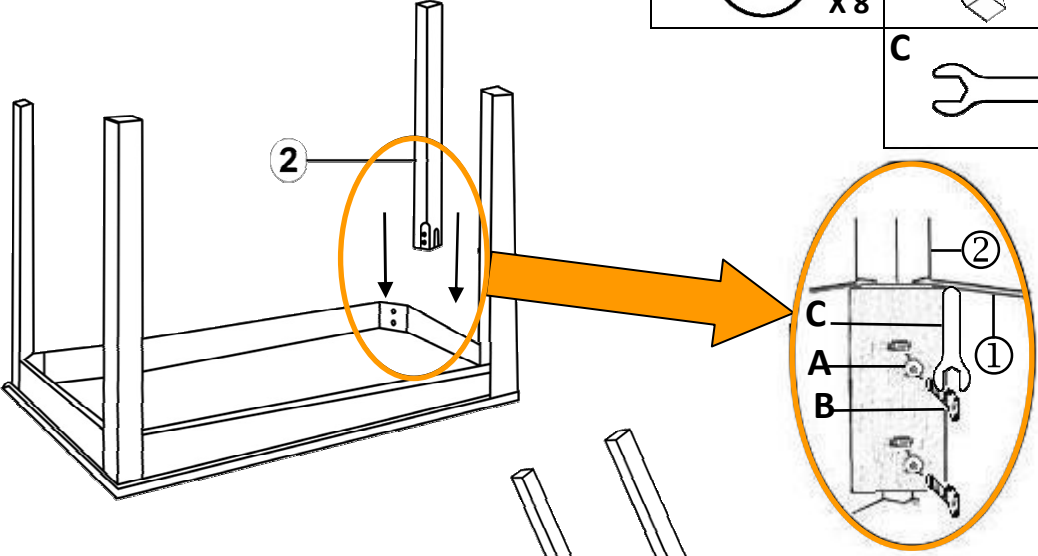

3

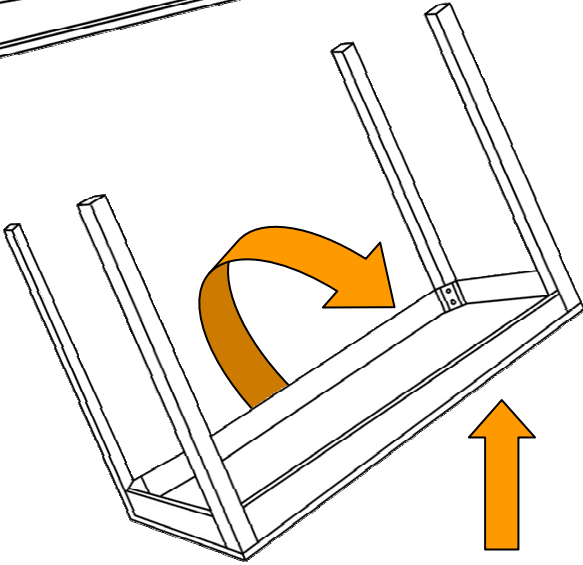

4

