

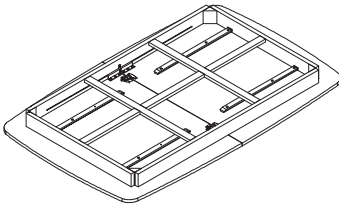

20 MIN



1



X1

2



X4

3

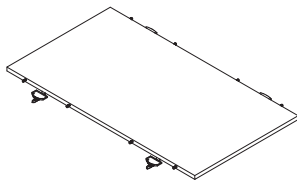

X1

**A** Ø8\*55mm

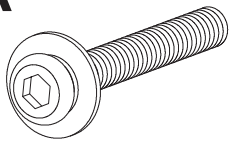

X8

**B**



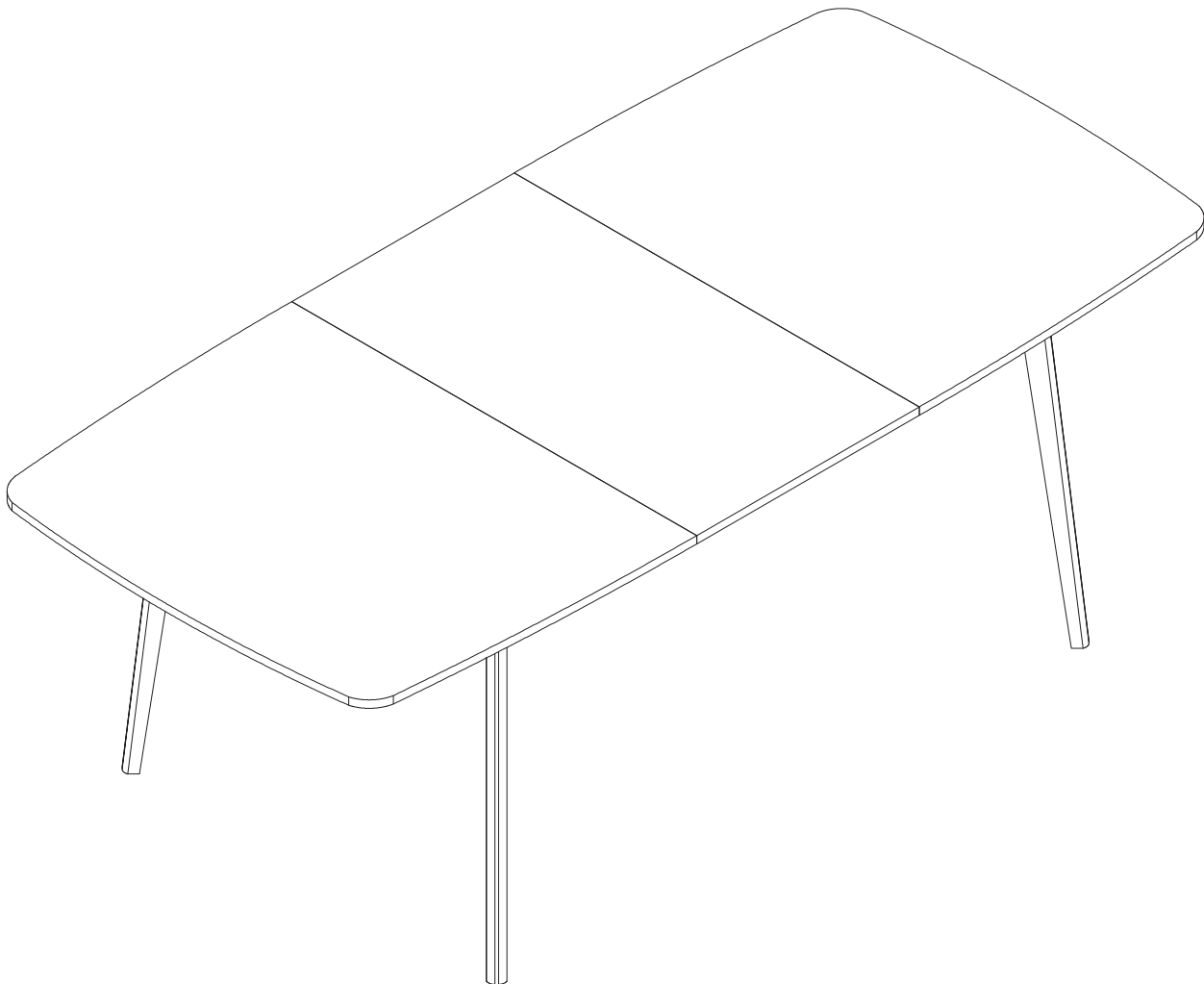

X1

**C**

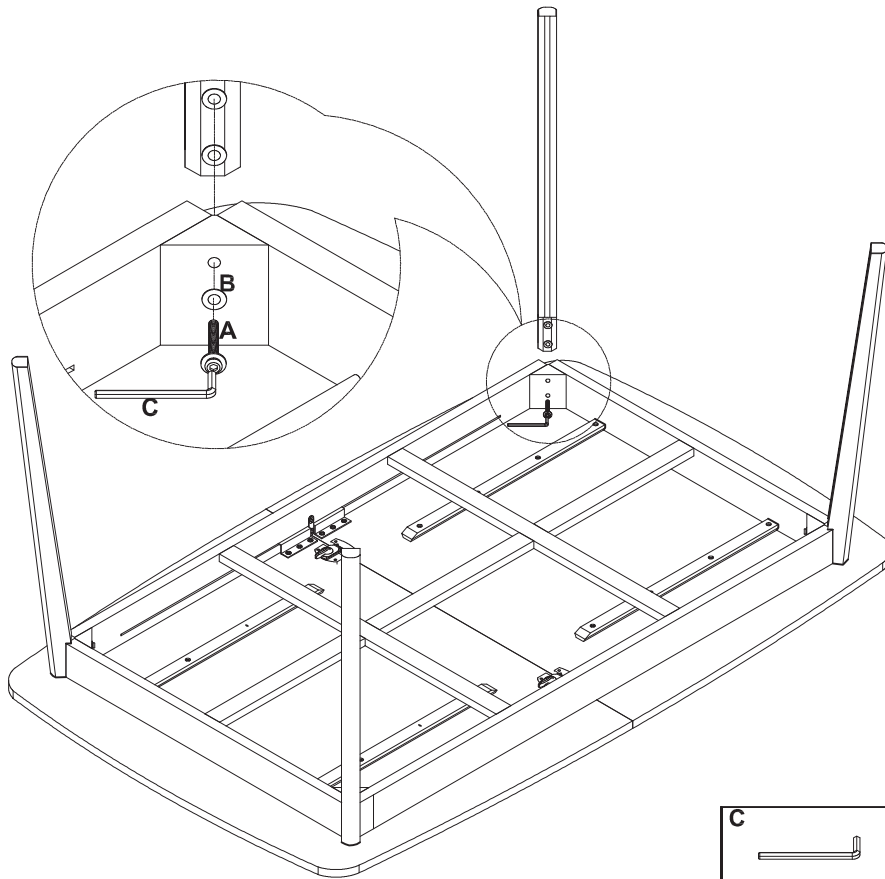

step 1

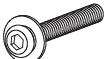

|   |   |   |
|---|---|---|
| <b>C</b><br><br>X1 | <b>B</b><br><br>X8 | <b>A</b> Ø8*55mm<br><br>X8 |
|---|---|---|

step 2

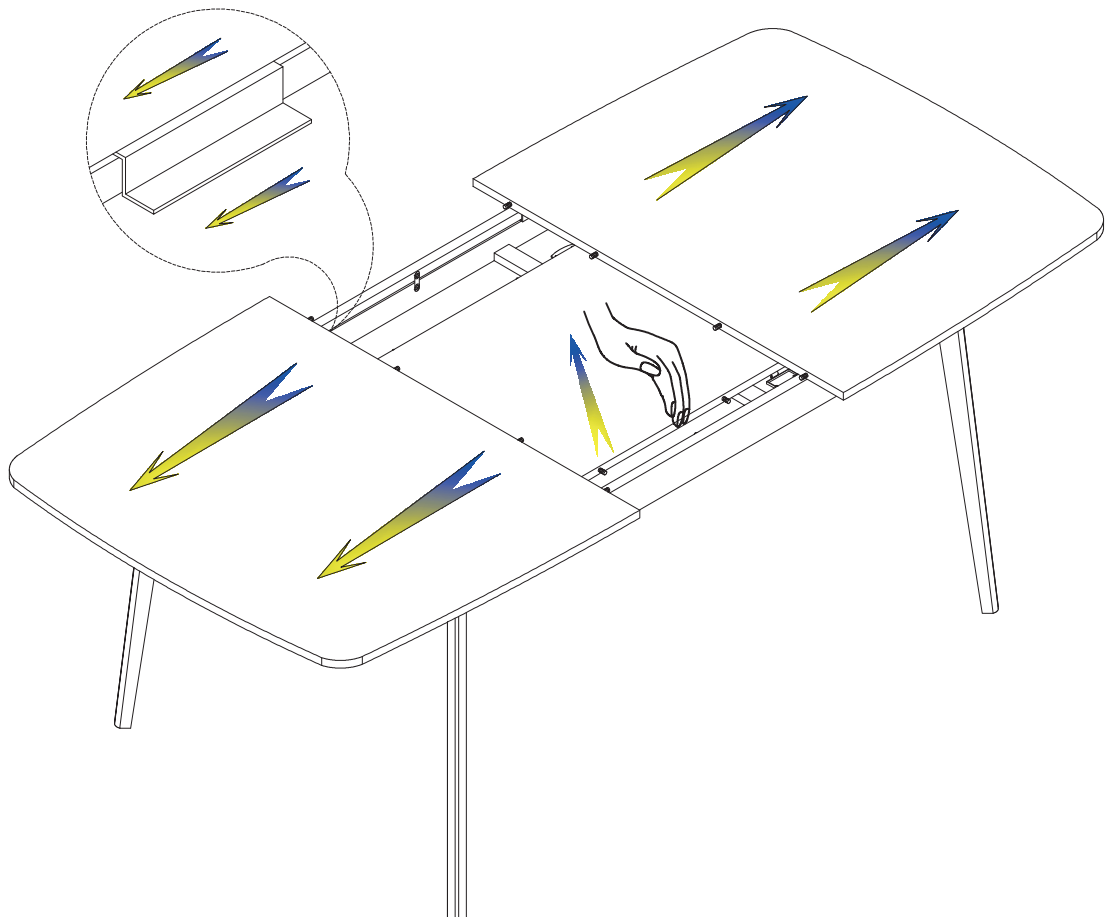

step 3

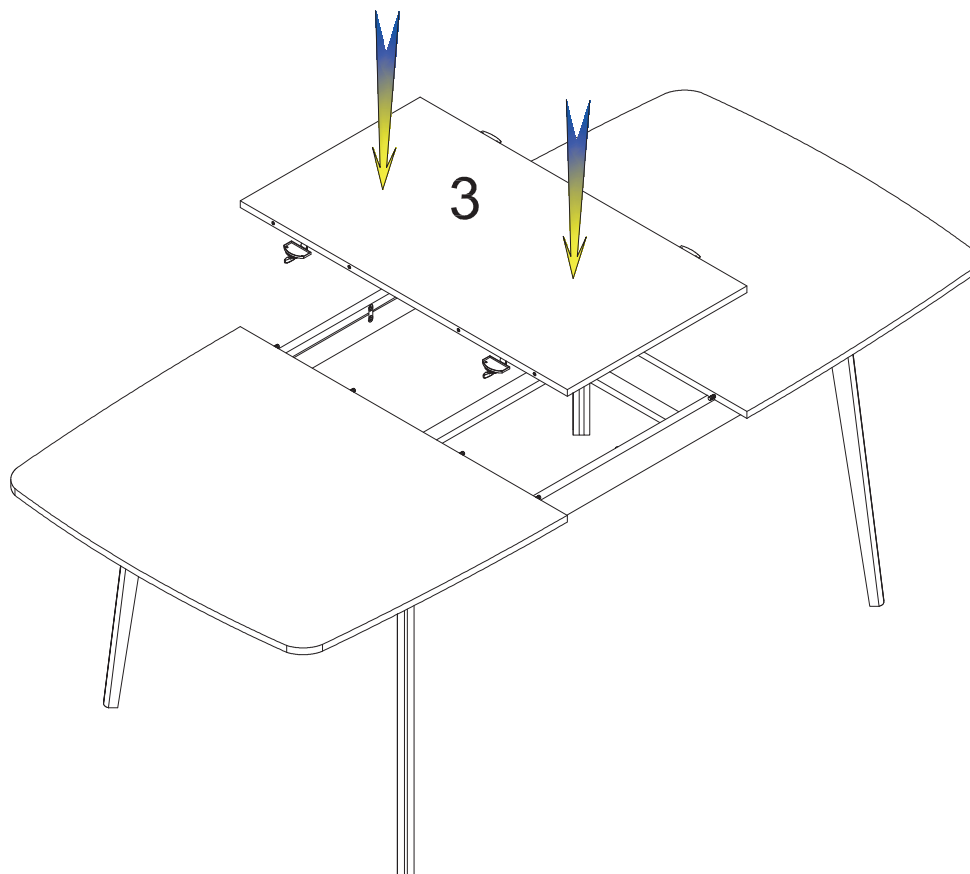

step 4

